



## Are you taking advantage of all that Thomas Scientific has to offer?

Thomas Scientific offers our customers many ways to save. In addition to our competitive pricing, customers can take advantage of special offers through *LabBUYER*, *Lab BASICS*, *Safety Spotlight*, *Equipment and Instrumentation Source Guide*, and more.

The **Equipment and Instrumentation Source Guide** is full of deals and solutions for your laboratory needs. Get the latest information on new products as well as helpful tips to save you time and money.

The **LabBasics** winter publication is full of your everyday lab essentials at great prices.

The **Brewery and Wine Brochure** is focused around top quality products for this growing industry.

The **Safety Spotlight** is focused around our Safety partners and the many offerings of Safety products available to you. Here you will find new products, as well as some items that anyone who cares about Safety should have in their work environment. Discounts and great deals on Safety products await you.

The **Thomas Scientific Forensics Catalog**, along with the current Supplement, is packed with products focussed on the Forensics industry.

Ask your local Thomas Sales Representative for copies of these and other publications we have available. Many publications can also be downloaded on our website, in our Deal Central section. Visit the Promotions & Literature tab on ThomasSci.com today to see the latest publications and promotions.

Interested in seeing weekly specials and new product announcements? Check out our email blasts that feature unique product specials, many of which are exclusive to Thomas Scientific. To receive our email blasts on a regular basis, please register on our website!

**So ask yourself ... Am I taking advantage of all that Thomas Scientific has to offer?**

# lab BUYER

Spring Edition 2018

Supplies • Equipment • Instruments • Chemicals/Reagents



**Corning**  
Purchase a Corning® CoolCell™ Container and a Case of Corning Cryogenic Vials to Receive 1 Case of Cryogenic Vials Free.  
See Page 5



**labForce**  
Ultra-High Speed Centrifuge Tubes  
Buy 3, Get 1 FREE!  
See Page 11



**Thomas Wiley Mill**  
The Original Lab Mill  
See Page 18



**New!**  
**Stretchease**  
Powder-Free Nitrile Examination Gloves  
See Page 9



**Look inside for more great deals!**



## WELCOME!

Thomas Scientific is a distributor of laboratory supplies, equipment and chemicals. The products in this catalog represent only a small offering from our extensive catalog and website. We're here to make your purchasing process as simple as possible. For additional models, sizes, packaging, and accessories not shown in our catalogs or if you just need help selecting a product, contact us at 800-345-2100 or visit us on the web at [www.thomassci.com](http://www.thomassci.com).



Thomas Scientific accepts VISA, Master Card, American Express and the IMPAC card for government buyers.

## OUR MISSION

To help science create a better world by providing quality products with personal, timely and efficient service  
*Delivering Quality Scientific Supplies Worldwide Since 1900*

Special offers and pricing are valid through June 30, 2018, unless otherwise noted.

**NOTE:** Offers in this catalog are void where prohibited by law or company policy. Shipping charges are not included. Prices and offers are subject to change without notice and are not to be combined with other offers/discounts or contract pricing. Valid in USA only. Dealer/reseller sales not applicable. For web orders, enter the promo code in the yellow box on the back of this catalog. For phone orders, please supply the promo code to the customer service representative when ordering. Discount pricing shown must be specified when placing order. Returned products will be subject to billing for Free Items at list price. Free items in 'Buy/Get 1 Free' offers will be the item of lowest value unless otherwise noted. Giveaways and free products may be shipped separately. Allow 4-6 weeks for delivery.

Suppliers featured in this issue are:



It's Just What Your Lab Needs

SUPPLIES • EQUIPMENT • INSTRUMENTS  
CHEMICALS • FURNITURE



Looking for additional offers?

Check out our

**Deal Central**

section on the web

[www.thomassci.com/deals](http://www.thomassci.com/deals)



**TS-B Series**  
Basic Portable Weighing  
Economical weighing  
Educational & general laboratory use

**TS-E Series**  
Economy Weighing  
Economy level balances / Basic weighing needs

**TS-L & TS-L.C Series**  
Standard Weighing  
Highly precise measurement

**TS-L.N Series**  
Standard Weighing  
with NTEP Certification

**TS-P Series**  
Portable Weighing  
Educational and light industrial use

**TS-T Series**  
Advanced Technology  
Advanced weighing performance  
Maximum ease-of-operation

**TS-U Series**  
Ultra-microbalances & microbalances  
Professional level of weighing  
Highest measurement accuracy

Please visit [thomassci.com](http://thomassci.com) Keywords: labForce Balances



Ansell

experience a  
**HIGHER LEVEL**  
of PROTECTION



Highest barrier  
quality & consistency\*  
(low 0.40 AQL)



**Microflex® 93-850 Nitrile Disposable Gloves with 2X more chemical splash protection†**

Introducing the innovative hand protection solution that stands up to tough jobs while significantly reducing workers' risk of exposure to hazardous materials and rips/tears. It's made using a breakthrough polymer bonding technique\* for 2X more chemical splash resistance.† And because these soft, durable gloves exceed the highest known standard for barrier quality and consistency,‡ they provide reliable protection in even the most challenging environments.

Request a sample at [ansell.com/microflex93850](http://ansell.com/microflex93850)

**MICROFLEX®**

\* Patent pending polymer bonding technique † Based on EN 374 and ASTM F739 chemical permeation test data, when compared to performance of disposable nitrile gloves of a similar weight. Visit [www.ansell.com/Microflex93-850chemtest](http://www.ansell.com/Microflex93-850chemtest) to view chemical permeation test data. ‡ Microflex 93-850 0.40 AQL is lower than the AQL of other known industrial and medical grade disposable gloves. Ansell, ® and ™ are trademarks owned by Ansell Limited or one of its affiliates. US Patented and US and non-US Patents Pending: [www.ansell.com/patentmarking](http://www.ansell.com/patentmarking) © 2018 Ansell Limited. All Rights Reserved.



# The Original Lab Mill

agopi  
LAB SOLUTIONS  
Model 4  
Wiley® Mill



The Wiley Mill, by Thomas Scientific, sets the standard of quality, efficiency, and value within the sample preparation market. With over 75 years of proven technology, Wiley Mills are the **most robust, longest lasting mills on the market!**

The Wiley Mill is **built by hand** and consists of an **all steel construction**, with four rotating steel cutting knives, easy cleaning, **no service tech required for maintenance** and a one year manufacturer's warranty. The mills are suggested by the U.S. Bureau of Plant Industry for milling of samples.

**Whatever your application, Thomas has a Mill for you!**

- Bio-fuel
- Agriculture
- Tobacco
- Meat & Poultry
- Biology
- Life Science
- Pet Food

### Models for Bench Mounting

Provided with four mounting lugs for bolting to bench or for attachment of (3375E90)Runners (not supplied). Includes jar and beaker chutes, three sieves (1/2, 1 and 2 mm), one stainless steel beaker (1527C25), three 1 pint (0.47 L) glass jars (6176B12), set of wrenches, one grease gun and 1 lb. (0.45 kg) of grease.

- Overall dimensions: 15" W x 24" D x 28" H (381 x 610 x 711 mm)
- Shipping weight: 375 lbs. (170 kg)
- Net weight: 301 lbs. (136.5 kg)

Thomas No.	Description
3375E15	Wiley® Mill, Model 4 Bench, 1 Hp, 115V, 50/60 Hz
3375E25	Wiley® Mill, Model 4 Bench, 1 Hp, 230V, 50/60 Hz
3375E55	Wiley® Mill, Model 4 Floor, 1 Hp, 230V, 50/60 Hz

### Models with Floor Stand

- Heavy channel stock steel construction
- Smooth rolling casters
- Accessory shelf
- Overall dimensions: 20" W x 26" D x 49" H
- Shelf dimensions: 13.8" W x 15.9" D x 1.8" H
- Floor stand (3375E81) dimensions: 20" W x 25" D x 23" H

Floor stand models include jar and beaker chutes, three sieves (1/2, 1 and 2 mm) one stainless steel beaker (1527C25), three 1 pint (0.47 L) glass jars (6176B12), set of wrenches, one grease gun and 1 lb. (0.45 kg) of grease.

**For more information about Thomas Wiley Mills contact your Thomas Scientific Sales Representative today!**

Want a FREE Sample Grinding? Visit [www.thomassci.com/wileymill](http://www.thomassci.com/wileymill)

## Purchase 2 cases of KIMBLE® Disposable Culture Tubes Get a FREE universal tube rack

These premium quality tubes feature sturdy, uniform bottoms and consistent lengths. The 10x75mm and 12x75mm sizes are suitable for cell washing procedures.

- 51 expansion borosilicate glass offers excellent chemical resistance against sodium leaching, a factor common in soda lime glass products
- Tubes are packed in convenient trays for ease of use on bench tops and in drawers
- Trays are shrink-wrapped in plastic film, with tubes remaining in constant alignment for protection against in-transit breakage and contamination
- No marking spot
- Designed from ASTM Specification E890
- Manufactured from 51 expansion borosilicate glass conforming to USP Type I and ASTM E438, Type I, Class B requirements

Thomas Number	Overflow Capacity (mL)	OD x Length (mm)	Case Qty
1178Z90	4	10 x 75	1000
1178Z91	6	12 x 75	1000
1178Z92	10	13 x 100	1000
1178Z94	15	16 x 100	1000
1178Z95	19	16 x 125	1000
1178Z96	23	16 x 150	1000

Visit [www.thomassci.com/deals](http://www.thomassci.com/deals) for redemption info.



Part number 1185P30  
\*accommodates sizes 10-17mm

DWK Life Sciences

## qTOWER<sup>3</sup> Series Quantitative Real Time PCR Thermal Cyclers

**analytikjena**  
An Endress+Hauser Company

Promo: Buy a qTOWER<sup>3</sup> - receive free equipment

### qTOWER<sup>3</sup> Thermal Cyclers feature:

- Open platform for all common plasticware types (96 well plates, 8 or 12 well strips and individual tubes)
- Fast, efficient ramping rates: heating 8°C/sec; cooling 6°C/sec
- Optimized for volumes of 10 - 80 µl with detection of 96 samples in 6 sec, regardless of number of targets
- qTOWER<sup>3</sup> G includes gradient temperature range of up to 40°C across 12 columns/zones
- 10 year warranty on system optical components; 2 year warranty on remainder of system

Free laptop loaded with qPCRsoft software for control and analysis  
Free color module 1 for SYBR Green/FAM/Alexa488 dyes  
Free starter kit with 96 well microplates and sealing films

Part #	Description	Price
1182K98	qTOWER <sup>3</sup> with free items	\$ 22,254.02
1182K99	qTOWER <sup>3</sup> G with free items	\$ 23,425.83

qTOWER 115V models listed. 10-year warranty provided on optical detection components. Additional color, FRET and protein modules available for loading up to 6 modules simultaneously. Go to [ThomasSci.com](http://ThomasSci.com) for additional specifications. Free items included with purchase. Offer valid in North America February 1, 2018 through March 31, 2019.

Free equipment  
valued at over  
\$3,000!





# Hamilton Microlab® 600 Diluters & Dispensers

For Labs Processing Over 50 Samples Per Day

## Sample Prep Perfected

- ▶▶ Reduce sample preparation times
- ▶▶ Increase throughput and reduce errors
- ▶▶ Eliminate user-to-user variation
- ▶▶ Simplify compliance
- ▶▶ Free up valuable laboratory resources



**Lightweight hand probe**  
A lightweight, disposable tip hand probe is available



Thomas No.	Mfr. No.	Description
1220B14	ML610-DIS	Microlab® 600 Single Syringe Dispenser with Basic Controller
1221W13	ML620-DIS	Microlab® 600 Single Syringe Dispenser with Advanced Controller
1221W11	ML615-DIS	Microlab® 600 Dual Syringe Dispenser with Basic Controller
1221W15	ML625-DIS	Microlab® 600 Dual Syringe Dispenser with Advanced Controller
1221W12	ML615-CNT	Microlab® 600 Dual Syringe Continuous Dispenser with Basic Controller
1221W16	ML625-CNT	Microlab® 600 Dual Syringe Continuous Dispenser with Advanced Controller
1221W10	ML615-DIL	Microlab® 600 Dual Syringe Diluter with Basic Controller
1221W14	ML625-DIL	Microlab® 600 Dual Syringe Diluter with Advanced Controller
1221W18	61500-02	Microlab® 600 Basic to Advanced Controller Upgrade Kit Includes: Advanced Manual, 2 GB SD Card, SD to USB Converter, and the Programmer Software CD
1221W19	61500-03	Microlab® 600 Custom Programmer Kit (compatible with .Net 2.0) Includes: Programmer Software CD which contains the Programmer Manual, Application Programming Interface, and Example LabView, C#, and VB Programs
1216P36	61500-04	Microlab® 600 Printer Kit

For more information, visit [www.thomassci.com/Equipment/Dispensers/\\_/Microlab-600-Dispensers-and-Diluters](http://www.thomassci.com/Equipment/Dispensers/_/Microlab-600-Dispensers-and-Diluters)

1-800-345-2100

[www.thomassci.com](http://www.thomassci.com)

©2018 Hamilton Company. All rights reserved. All trademarks are owned and/or registered by Hamilton Company in the U.S. and/or other countries.



## YOUR CHOICE — Buy 2 GET 1 FREE!\*

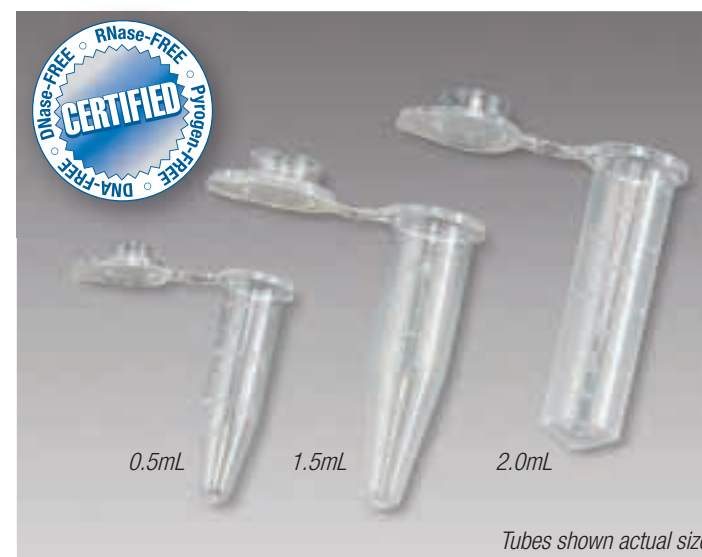

### 0.5mL, 1.5mL & 2.0mL Microcentrifuge Tubes In Self-Standing Bags

These premium quality microcentrifuge tubes are manufactured from FDA approved resins and are certified to be RNase free, DNase free, DNA free and Pyrogen free.

- Supplied in resealable, tamper-evident self-standing bags
- Large, clearly printed graduations
- Frosted writing area on each tube
- Smooth surfaces won't catch or tear gloves
- Thin cap membrane for trouble-free needle piercing
- Fit all standard and high capacity centrifuge rotors
- Can be centrifuged at up to 20,000 RCF
- Withstand temperatures from -80°C to +121°C
- Food grade
- Three volume and eight color options
- Polypropylene (PP)



\*Offers valid thru June 30, 2018. Mix & match. Item of equal or lesser value free.

Visit [thomassci.com/deals](http://thomassci.com/deals) for qualifying products and redemption forms.



### 5mL Macrocentrifuge Tubes Screw Cap & Snap Cap

Efficient, economical alternative to 15mL conical tubes when working with sample volumes between 2.0mL and 5.0mL.

#### 5mL Screw Cap Macrocentrifuge Tubes

- Single turn threaded caps seal easily and securely
- Graduated in 0.5mL increments
- Available non-sterile in bags and sterile in bags or foam racks
- Suitable for use from -86° to 80° C
- Polypropylene (PP) with polyethylene (PE) screw cap



#### 5mL Snap Cap Macrocentrifuge Tubes

- Convenience of 1.5mL microcentrifuge tube in a tube that holds larger volumes
- Attached snap cap facilitates one handed opening and closing
- Pierceable cap allows easy access by needle or syringe
- Dual graduation scales in increments of 0.5mL and 0.2mL
- Suitable for use from -86° to 80° C
- Seven color options
- Polypropylene (PP)





thermo scientific

## Check out these great offers from Thermo Scientific by June 30!

### Clicktainer Vials

Providing ultimate sample protection and user safety by ensuring correct cap application the first time

#### Thermo Scientific™ Samco™ Clicktainer™ Vials

Clicktainer vials have a wide opening and leak proof seal. The “click” seal system indicates when the cap is properly applied so the sample is secure. Sample collection and transport made easy!



Purchase 3 cases and get a case at no additional charge!

**SAVE NOW!**

### Transfer Pipettes

Conveniently transfer liquids with precision

#### Thermo Scientific™ Samco™ Transfer Pipettes are:

- Made of shatterproof, non-toxic polyethylene
- Can be frozen in liquid nitrogen, or heat sealed for storage
- Low-affinity surface reduces loss of cells and valuable proteins due to binding



Purchase 3 cases and get a case at no additional charge!

**SAVE NOW!**

### Loops and Needles

Precision molded to provide a smooth loop surface

#### Thermo Scientific™ Nunc™ Loops and Needles are:

- Precision molded from nontoxic (USP Class VI) polystyrene material to provide a smooth loop surface
- Made of high quality plastics for use in biotechnology, pharmaceutical and research laboratories
- Useful in the production of vaccines and diagnostic kits



Purchase 3 cases and get a case at no additional charge!

**SAVE NOW!**

Take advantage of these great product offers at:

[thomasci.com/deals](http://thomasci.com/deals)

**Thermo Fisher**  
SCIENTIFIC

For Research Use Only. Not for use in diagnostic procedures. © 2018 Thermo Fisher Scientific Inc. All rights reserved. All trademarks are the property of Thermo Fisher Scientific and its subsidiaries unless otherwise specified. TLBCONSAD 0218

# Dispensette S

Bottletop Dispenser **Buy 3, get 1 FREE!**

Setting the Standard for a Half Century!

#### BRAND Dispensette® S bottletop dispensers

- Reduced operating forces
- Easier maintenance
- Positive volume selection



Lab Rats Trust BrandTech®!

Details at [www.thomasci.com/deals](http://www.thomasci.com/deals)



**BRANDTECH**  
SCIENTIFIC, INC.

## Star™ T910 pH Titrators

Potentiometric titrator for accurate pH titrations with easily reportable results.

The **Thermo Scientific™ Orion™ T910 pH titrators** are designed to increase your laboratory productivity by automating titrations. Our core electrochemistry technology is integrated with a state-of-the-art reagent dispensing system to create modern, simplified automated titrators designed to make performing titrations easier, more reliable and more reproducible than manual titrations.

Use the **Orion Star T910 pH titrator** for dedicated acid-base titrations including:



- Titratable acidity of juices and wines
- Acidity of food products
- Alkalinity of waters
- Acidity and alkalinity of consumer products
- Total acid number (TAN)
- Total base number (TBN)

Titration techniques include equivalence point titrations and preset pH endpoint titrations for versatile sample analysis. The automated titrant delivery system with high-accuracy burette and dispenser provides consistent results. Automatic results calculations simplifies analysis and reduces computational errors.



Thomas No.	Description
1160V89	Orion Star T910 pH Titrator (without electrode), 100-240V, 50/60Hz
1160V90	Orion Star T910 pH Titrator Standard ROSS Kit, 100-240V, 50/60Hz
1160V91	Orion Star T910 pH Titrator ROSS Sure-Flow Kit, 100-240V, 50/60Hz

Visit [thomasci.com](http://thomasci.com) Search: 1160V89

thermo scientific



Traceable® Thermometers, Timers and Stopwatches



**Traceable® Jumbo Display Refrigerator/Freezer Thermometer**

- Accurately monitor temperatures with enclosed temperature-buffered sensor
- Fulfills all CDC thermometer and vaccine thermometer requirements
- Alarm feature will alert when temperature rises above or falls below a set point
- Alarm feature provides alert when temperature rises above or falls below a set point

Thomas No.	Description
1226M01	Jumbo Display Refrigerator/Freezer Vaccine Thermometer



**Traceable® Refrigerator/Freezer Thermometer**

- Enclosed "temperature buffered" sensor
- Range: -50 to 70°C (-58 to 158°F)
- Resolution: 1°C; accuracy: ±1°C
- Glycol bottle insulates sensor from rapid temperature changes
- High-impact, chemical-resistant ABS case

Thomas No.	Description
1222W14	Jumbo Display Refrigerator/Freezer Vaccine Thermometer



**Thomas Traceable Big-Digit Stopwatch/Chronograph**

- Giant-Digits with 1-1/3 inch digit height
- Viewable from 50 feet
- Countdown and alarms on single channel for ease-of-use
- Three-button intuitive operation eliminates reading instructions
- Automatic Bounceback™ Memory for repetitive timing

Thomas No.	Description
1229S18	Jumbo Display Refrigerator/Freezer Vaccine Thermometer

**Thomas Traceable Giant Digit Timer**



- Giant-Digits with 1-1/3 inch digit height
- Viewable from 50 feet
- Countdown and alarms on single channel for ease-of-use
- Three-button intuitive operation eliminates reading instructions
- Automatic Bounceback™ Memory for repetitive timing

Thomas No.	Description
1235C27	Traceable Big-Digit Stopwatch / Chronograph

From Vaccine temperature control to stopwatches, we have products for all of your needs! For more information about Thomas Traceable thermometers, timers and stopwatches visit [thomassci.com](http://thomassci.com) Search: **traceable**



thermo scientific

**Thermo Scientific™ TSX Series Refrigerators and Freezers**

**TSX ultra-low freezers**

- Four sizes combined: 400, 500, 600 or 700 box capacity (2-inch box)
- Energy savings: just 6.5 kWh/day (TSX400) and 7.8 kWh/day (TSX600) at -70°C setpoint
- Quiet: only 47.4 dBA (TSX400) and 46.9 dBA (TSX600) and 48.0 dBA (TSX700)

**NEW—TSX Series high-performance lab refrigerators**

- Quiet: just 52 dBA—up to 10x quieter than previous generation\*
- V-drive: significant reduction in energy with alternate compressor technology
- Ergonomic design: slanted controller to help prevent neck strain and comfortable door handle

**NEW—TSX Series high-performance lab freezers**

- Two choices: -30°C auto defrost or -20°C manual defrost
- Quiet: just 52 dBA for -30°C and 50 dBA for -20°C
- V-drive: significant reduction in energy with alternate compressor technology



Find out more at [thomassci.com/tsx](http://thomassci.com/tsx)

**ThermoFisher**  
SCIENTIFIC

For Research Use Only. Not for use in diagnostic procedures. © 2018 Thermo Fisher Scientific Inc. All rights reserved. ENERGY STAR name and logo are trademarks of the U.S. EPA. All other trademarks are the property of Thermo Fisher Scientific and its subsidiaries unless otherwise specified. THOMASLBTSX 0218

**Thomas Analog and Digital Dry Block Heaters**

**Holds interchangeable modular blocks**

- Exceptional temperature uniformity and stability
- Uniform temperature control
- LED display
- Optional external temperature probe
- 2-year warranty



Blocks available. Visit [thomassci.com](http://thomassci.com) Search: **1231R87**



•••• Analog ••••

Thomas No.	Description
1231H15	Analog 1 Block Heater 120V
1231H16	Analog 1 Block Heater 230V
1231H17	Analog 2 Block Heater 120V
1231H18	Analog 2 Block Heater 230V
1231H19	Analog 3 Block Heater 120V
1231H20	Analog 3 Block Heater 230V
1231H21	Analog 4 Block Heater 120V
1231H22	Analog 4 Block Heater 230V
1231H23	Analog 6 Block Heater 120V
1231H24	Analog 6 Block Heater 230V

•••• Digital ••••

Thomas No.	Description
1231H05	Digital 1 Block Heater 120V
1231H06	Digital 1 Block Heater 230V
1231H07	Digital 2 Block Heater 120V
1231H08	Digital 2 Block Heater 230V
1231H09	Digital 3 Block Heater 120V
1231H10	Digital 4 Block Heater 230V
1231H11	Digital 4 Block Heater 120V
1231H12	Digital 4 Block Heater 230V
1231H13	Digital 6 Block Heater 120V
1231H14	Digital 6 Block Heater 230V
1229E95	Temperature Probe Kit Heatblock Digitl





FILTER TECHNOLOGY

## INTRODUCING ABLUO SYRINGE FILTERS BY GVS!

MADE IN THE USA!  
NEVER SACRIFICE QUALITY FOR PRICE!  
SAMPLES AVAILABLE!

Contact your local Account Manager  
for additional details and samples!



AFG provides products to support  
your R&D research in **Biotechnology,**  
**Pharmaceutical** and **Agricultural Markets.**

Now Available at **Thomas Scientific!**



## Thomas® Microscope Cover Glass

Our Thomas® microscope cover glass is packaged: 1 oz per pack, 10 packs/box (10 oz). Each fliptop pack contains a desiccant and is wrapped in aluminum to prevent sticking.

Available in two thicknesses:

- No. 1: 0.14mm
- No. 1.5: 0.175mm

Thomas No.	Description
1169W09	Cover Glass, 22 x 22mm, No. 1
1169W10	Cover Glass, 22 x 22mm, No. 1.5
1169W11	Cover Glass, 24 x 50mm, No. 1
1169W12	Cover Glass, 24 x 60mm, No. 1







### White Glass Frosted Microscope Slides

- Pre-cleaned and ready to use
- Produced from the finest quality optical white glass
- Chemically etched frosting
- Packed in high-quality white plastic boxes
- Dimensions: 25 x 75mm
- Thickness: 1mm
- Packaging: 72/plastic box, 20 boxes/case (10/gross)

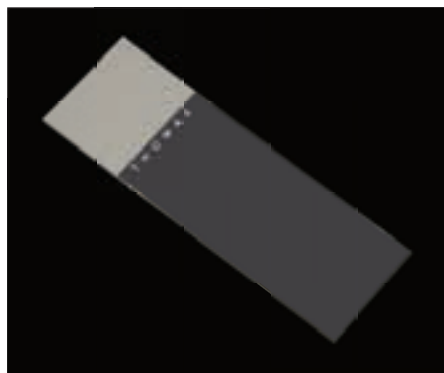

Thomas No.	Description
1169W07	Microscope Slide, White Glass, Frost, 25 x 75mm

### White Glass Microscope Slides

Thomas No.	Description
1169W06	Microscope Slide, White Glass, Plain, 25 x 75mm

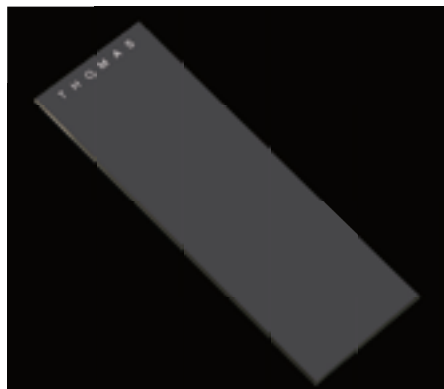

### White Glass Color Frosted Microscope Slides

Thomas No.	Description
1169W08	Microscope Slide, White Glass, White Frost, 25 x 75mm



## stretchease

Powder-Free Nitrile Examination Gloves

- Powder free
- More chemical resistant
- Exceptional strength
- Textured



A great alternative for people who are sensitive to latex!

Thomas No.	Description	Quantity	
		Pack	Case
1159G03	Stretchease, Powder Free, Nitrile Exam Gloves, XS	100	1000
1159G04	Stretchease, Powder Free, Nitrile Exam Gloves, S	100	1000
1159G05	Stretchease, Powder Free, Nitrile Exam Gloves, M	100	1000
1159G06	Stretchease, Powder Free, Nitrile Exam Gloves, L	100	1000
1159G07	Stretchease, Powder Free, Nitrile Exam Gloves, XL	100	1000
1159G08	Stretchease, Powder Free, Nitrile Exam Gloves, XS - Big Case Quantity	—	2500
1159G09	Stretchease, Powder Free, Nitrile Exam Gloves, S - Big Case Quantity	—	2500
1159G10	Stretchease, Powder Free, Nitrile Exam Gloves, M - Big Case Quantity	—	2500
1159G11	Stretchease, Powder Free, Nitrile Exam Gloves, L - Big Case Quantity	—	2500
1159G12	Stretchease, Powder Free, Nitrile Exam Gloves, XL - Big Case Quantity	—	2300



Easiest calibration and verification with accurate results every time.

## 2100Q Portable Turbidimeter



Meets EPA Method 180.1

- **Single-standard RapidCal™ calibration** offers the simplest solution for low-level measurements
- **Single-step verification** and on-screen assisted calibration eliminates the need to reference complicated manuals
- **Optional USB module** enables simple data transfer. All data is easily downloaded to any computer, providing superior data integrity and availability
- **Exclusive algorithm** in the Rapidly Settling Turbidity™ mode provides accurate, repeatable measurements for rapidly settling, difficult-to-measure samples while eliminating the need for redundant measurements and estimating

Please visit [thomassci.com](http://thomassci.com) for more product information *Keyword: 1224Y43*



**labForce**  
powered by Thomas Scientific

Manufactured and packaged in a clean room

## Weighing Boats

Flexible polystyrene boats feature smooth surfaces to provide accurate pourouts with minimal sample loss

- Select white or blue for best color contrast to ensure sample is completely removed
- Biologically inert and resistant to dilute and weak acids, aqueous solutions, alcohols, and bases
- Temperature range -10 to 70°C (14 to 158°F)
- Can be used with microwave moisture analyzers
- **All are FDA/food-grade compliant**
- **Disposable**

Smooth surfaces provide accurate pour-outs



### Standard weighing boats

- Boats are shallow with a wide, flat bottom to resist tipping
- Rounded corners simplify transfer



### Hexagonal weighing boats

- Bend flexible boats at points to form pour spouts
- Flat bottoms and sloping sides provide accurate transfer



### Pour-boat weighing boats

- Pour-spout design easily dispenses samples without flexing the dish
- Flat-bottom dishes are made from 12-mil thick polystyrene for better strength, stability, and handling



Please visit [www.thomasci.com](http://www.thomasci.com) for more product information. Keyword: labForce Weigh Boats

**Buy 3 Get 1 FREE!**

Offer valid April 1, 2018 thru June 30th, 2018.

LabForce Ultra-High-Speed 15mL & 50mL Centrifuge Tubes have been designed for high speed centrifugation and meet the demands of the most crucial scientific work.

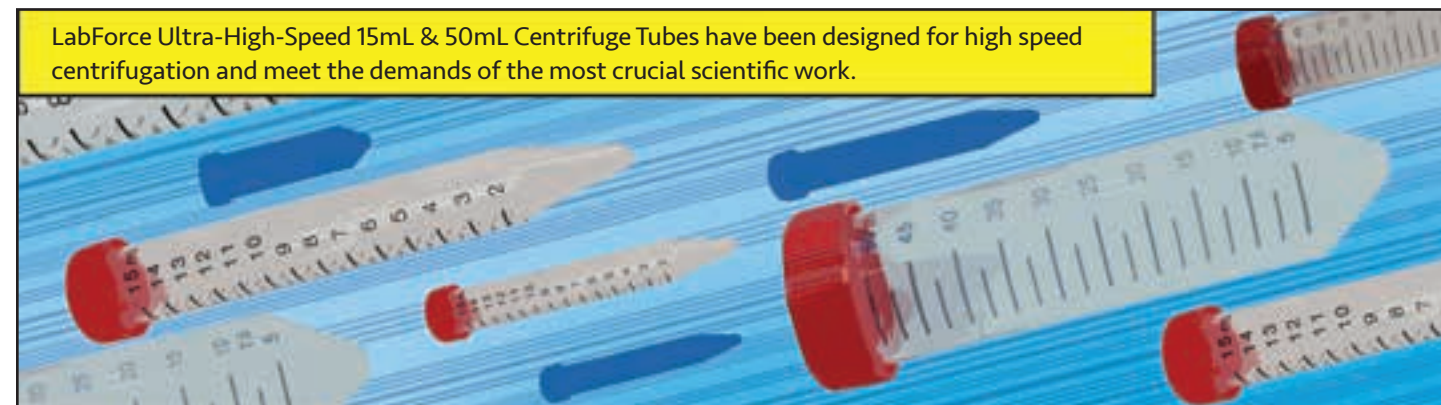

### FEATURES AND BENEFITS:

- ★ **Ultra-High Performance** - High spin rates with maximum RCF ratings of up to 20,000 x g for 50mL centrifuge tubes and 17,000 x g for 15mL centrifuge tubes
- ★ **Certified for Science<sup>SM</sup>** - Tubes are manufactured in a class 100,000 clean room, gamma irradiated to SAL 10-6, and are certified to be free from DNase, RNase, Human DNA, Pyrogens, and Endotoxins, giving you peace of mind to know they meet the requirements for the most critical scientific testing methods
- ★ **Value** - Efficient automated production reduces cost and assures high quality products that is consistent from lot to lot
- ★ **Premium Materials** - USP Class VI resin is also FDA CFR 2 compliant for food safety
- ★ **Leak Resistant** - Easy Grip Caps have an integral seal ring design for secure closures that eliminate leakage when used as recommended
- ★ **Ease of Use** - Exceptionally clear tubes have black printed graduation marks to full volume of 15mL or 50mL, a bright white marking space, and are packaged in heavy duty, zip, re-closable bags for easy use
- ★ **Eco Friendly** - Paperboard racks are readily recyclable in the well-established paper recycling stream



Thomas No.	Description	Qty/Case
1163X42	High Speed Centrifuge Tube, 15mL, Red Cap, Polypropylene, Sterile, Bag	500
1163X43	High Speed Centrifuge Tube, 15mL, Red Cap, Polypropylene, Sterile, Rack	500
1163X44	High Speed Centrifuge Tube, 50mL, Red Cap, Polypropylene, Sterile, Bag	500
1163X45	High Speed Centrifuge Tube, 50mL, Red Cap, Polypropylene, Sterile, Rack	500

Please visit [www.thomasci.com/deals](http://www.thomasci.com/deals) for redemption info.





**labForce**  
powered by Thomas Scientific

**Manufactured and packaged in a clean room**

## Weighing Boats

Flexible polystyrene boats feature smooth surfaces to provide accurate pourouts with minimal sample loss

- Select white or blue for best color contrast to ensure sample is completely removed
- Biologically inert and resistant to dilute and weak acids, aqueous solutions, alcohols, and bases
- Temperature range -10 to 70°C (14 to 158°F)
- Can be used with microwave moisture analyzers
- **All are FDA/food-grade compliant**
- **Disposable**

**Smooth surfaces provide accurate pour-outs**



**Standard weighing boats**

- Boats are shallow with a wide, flat bottom to resist tipping
- Rounded corners simplify transfer



**Hexagonal weighing boats**

- Bend flexible boats at points to form pour spouts
- Flat bottoms and sloping sides provide accurate transfer



**Pour-boat weighing boats**

- Pour-spout design easily dispenses samples without flexing the dish
- Flat-bottom dishes are made from 12-mil thick polystyrene for better strength, stability, and handling



Please visit [www.thomasci.com](http://www.thomasci.com) for more product information. Keyword: **labForce Weigh Boats**

# Buy 3 Get 1 FREE!

Offer valid April 1, 2018 thru June 30th, 2018.

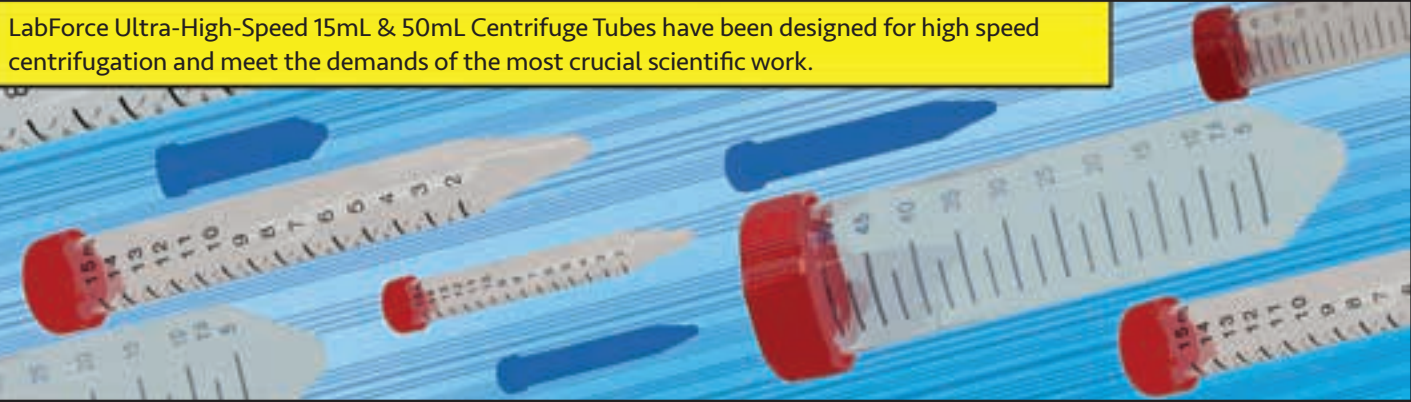

### FEATURES AND BENEFITS:

- ★ **Ultra-High Performance** - High spin rates with maximum RCF ratings of up to 20,000 x g for 50mL centrifuge tubes and 17,000 x g for 15mL centrifuge tubes
- ★ **Certified for Science<sup>SM</sup>** - Tubes are manufactured in a class 100,000 clean room, gamma irradiated to SAL 10-6, and are certified to be free from DNase, RNase, Human DNA, Pyrogens, and Endotoxins, giving you peace of mind to know they meet the requirements for the most critical scientific testing methods
- ★ **Value** - Efficient automated production reduces cost and assures high quality products that is consistent from lot to lot
- ★ **Premium Materials** - USP Class VI resin is also FDA CFR 21 compliant for food safety
- ★ **Leak Resistant** - Easy Grip Caps have an integral seal ring design for secure closures that eliminate leakage when used as recommended
- ★ **Ease of Use** - Exceptionally clear tubes have black printed graduation marks to full volume of 15mL or 50mL, a bright white marking space, and are packaged in heavy duty, zip, re-closable bags for easy use
- ★ **Eco Friendly** - Paperboard racks are readily recyclable in the well-established paper recycling stream



Thomas No.	Description	Qty/Case
1163X42	High Speed Centrifuge Tube, 15mL, Red Cap, Polypropylene, Sterile, Bag	500
1163X43	High Speed Centrifuge Tube, 15mL, Red Cap, Polypropylene, Sterile, Rack	500
1163X44	High Speed Centrifuge Tube, 50mL, Red Cap, Polypropylene, Sterile, Bag	500
1163X45	High Speed Centrifuge Tube, 50mL, Red Cap, Polypropylene, Sterile, Rack	500

Please visit [www.thomasci.com/deals](http://www.thomasci.com/deals) for redemption info.







### White Glass Frosted Microscope Slides

- Pre-cleaned and ready to use
- Produced from the finest quality optical white glass
- Chemically etched frosting
- Packed in high-quality white plastic boxes
- Dimensions: 25 x 75mm
- Thickness: 1mm
- Packaging: 72/plastic box, 20 boxes/case (10/gross)

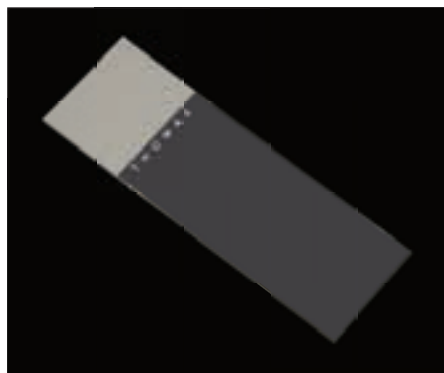

Thomas No.	Description
1169W07	Microscope Slide, White Glass, Frost, 25 x 75mm

### White Glass Microscope Slides

Thomas No.	Description
1169W06	Microscope Slide, White Glass, Plain, 25 x 75mm

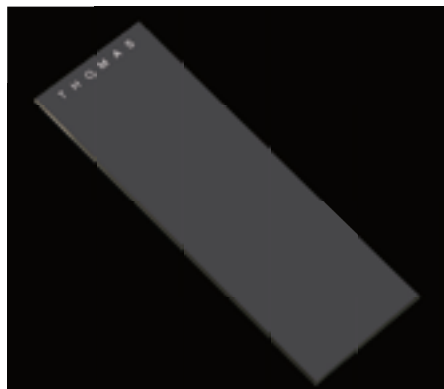

### White Glass Color Frosted Microscope Slides

Thomas No.	Description
1169W08	Microscope Slide, White Glass, White Frost, 25 x 75mm



## stretchease

Powder-Free Nitrile Examination Gloves

- Powder free
- More chemical resistant
- Exceptional strength
- Textured



Thomas No.	Description	Quantity	
		Pack	Case
1159G03	Stretchease, Powder Free, Nitrile Exam Gloves, XS	100	1000
1159G04	Stretchease, Powder Free, Nitrile Exam Gloves, S	100	1000
1159G05	Stretchease, Powder Free, Nitrile Exam Gloves, M	100	1000
1159G06	Stretchease, Powder Free, Nitrile Exam Gloves, L	100	1000
1159G07	Stretchease, Powder Free, Nitrile Exam Gloves, XL	100	1000
1159G08	Stretchease, Powder Free, Nitrile Exam Gloves, XS - Big Case Quantity	—	2500
1159G09	Stretchease, Powder Free, Nitrile Exam Gloves, S - Big Case Quantity	—	2500
1159G10	Stretchease, Powder Free, Nitrile Exam Gloves, M - Big Case Quantity	—	2500
1159G11	Stretchease, Powder Free, Nitrile Exam Gloves, L - Big Case Quantity	—	2500
1159G12	Stretchease, Powder Free, Nitrile Exam Gloves, XL - Big Case Quantity	—	2300



Easiest calibration and verification with accurate results every time.

## 2100Q Portable Turbidimeter



Meets EPA Method 180.1

- **Single-standard RapidCal™ calibration** offers the simplest solution for low-level measurements
- **Single-step verification** and on-screen assisted calibration eliminates the need to reference complicated manuals
- **Optional USB module** enables simple data transfer. All data is easily downloaded to any computer, providing superior data integrity and availability
- **Exclusive algorithm** in the Rapidly Settling Turbidity™ mode provides accurate, repeatable measurements for rapidly settling, difficult-to-measure samples while eliminating the need for redundant measurements and estimating

Please visit [thomassci.com](http://thomassci.com) for more product information *Keyword: 1224Y43*





FILTER TECHNOLOGY

## INTRODUCING ABLUO SYRINGE FILTERS BY GVS!

MADE IN THE USA!  
NEVER SACRIFICE QUALITY FOR PRICE!  
SAMPLES AVAILABLE!

Contact your local Account Manager  
for additional details and samples!



AFG provides products to support  
your R&D research in **Biotechnology,**  
**Pharmaceutical** and **Agricultural Markets.**

Now Available at **Thomas Scientific!**



## Thomas<sup>®</sup> Microscope Cover Glass

Our Thomas<sup>®</sup> microscope cover glass is packaged: 1 oz per pack, 10 packs/box (10 oz). Each fliptop pack contains a desiccant and is wrapped in aluminum to prevent sticking.

Available in two thicknesses:

- No. 1: 0.14mm
- No. 1.5: 0.175mm

Thomas No.	Description
1169W09	Cover Glass, 22 x 22mm, No. 1
1169W10	Cover Glass, 22 x 22mm, No. 1.5
1169W11	Cover Glass, 24 x 50mm, No. 1
1169W12	Cover Glass, 24 x 60mm, No. 1





Traceable® Thermometers, Timers and Stopwatches



**Traceable® Jumbo Display Refrigerator/Freezer Thermometer**

- Accurately monitor temperatures with enclosed temperature-buffered sensor
- Fulfills all CDC thermometer and vaccine thermometer requirements
- Alarm feature will alert when temperature rises above or falls below a set point
- Alarm feature provides alert when temperature rises above or falls below a set point

Thomas No.	Description
1226M01	Jumbo Display Refrigerator/Freezer Vaccine Thermometer



**Traceable® Refrigerator/Freezer Thermometer**

- Enclosed "temperature buffered" sensor
- Range: -50 to 70°C (-58 to 158°F)
- Resolution: 1°C; accuracy: ±1°C
- Glycol bottle insulates sensor from rapid temperature changes
- High-impact, chemical-resistant ABS case

Thomas No.	Description
1222W14	Jumbo Display Refrigerator/Freezer Vaccine Thermometer



**Thomas Traceable Big-Digit Stopwatch/Chronograph**

- Giant-Digits with 1-1/3 inch digit height
- Viewable from 50 feet
- Countdown and alarms on single channel for ease-of-use
- Three-button intuitive operation eliminates reading instructions
- Automatic Bounceback™ Memory for repetitive timing

Thomas No.	Description
1229S18	Jumbo Display Refrigerator/Freezer Vaccine Thermometer

**Thomas Traceable Giant Digit Timer**



- Giant-Digits with 1-1/3 inch digit height
- Viewable from 50 feet
- Countdown and alarms on single channel for ease-of-use
- Three-button intuitive operation eliminates reading instructions
- Automatic Bounceback™ Memory for repetitive timing

Thomas No.	Description
1235C27	Traceable Big-Digit Stopwatch / Chronograph

From Vaccine temperature control to stopwatches, we have products for all of your needs! For more information about Thomas Traceable thermometers, timers and stopwatches visit [thomassci.com](http://thomassci.com) Search: **traceable**



thermo scientific

**Thermo Scientific™ TSX Series Refrigerators and Freezers**

**TSX ultra-low freezers**

- Four sizes combined: 400, 500, 600 or 700 box capacity (2-inch box)
- Energy savings: just 6.5 kWh/day (TSX400) and 7.8 kWh/day (TSX600) at -70°C setpoint
- Quiet: only 47.4 dBA (TSX400) and 46.9 dBA (TSX600) and 48.0 dBA (TSX700)

**NEW—TSX Series high-performance lab refrigerators**

- Quiet: just 52 dBA—up to 10x quieter than previous generation\*
- V-drive: significant reduction in energy with alternate compressor technology
- Ergonomic design: slanted controller to help prevent neck strain and comfortable door handle

**NEW—TSX Series high-performance lab freezers**

- Two choices: -30°C auto defrost or -20°C manual defrost
- Quiet: just 52 dBA for -30°C and 50 dBA for -20°C
- V-drive: significant reduction in energy with alternate compressor technology



Find out more at [thomassci.com/tsx](http://thomassci.com/tsx)

**ThermoFisher**  
SCIENTIFIC

For Research Use Only. Not for use in diagnostic procedures. © 2018 Thermo Fisher Scientific Inc. All rights reserved. ENERGY STAR name and logo are trademarks of the U.S. EPA. All other trademarks are the property of Thermo Fisher Scientific and its subsidiaries unless otherwise specified. THOMASLBTSX 0218

**Thomas Analog and Digital Dry Block Heaters**

**Holds interchangeable modular blocks**

- Exceptional temperature uniformity and stability
- Uniform temperature control
- LED display
- Optional external temperature probe
- 2-year warranty



Blocks available. Visit [thomassci.com](http://thomassci.com) Search: **1231R87**



•••• Analog ••••

Thomas No.	Description
1231H15	Analog 1 Block Heater 120V
1231H16	Analog 1 Block Heater 230V
1231H17	Analog 2 Block Heater 120V
1231H18	Analog 2 Block Heater 230V
1231H19	Analog 3 Block Heater 120V
1231H20	Analog 3 Block Heater 230V
1231H21	Analog 4 Block Heater 120V
1231H22	Analog 4 Block Heater 230V
1231H23	Analog 6 Block Heater 120V
1231H24	Analog 6 Block Heater 230V

•••• Digital ••••

Thomas No.	Description
1231H05	Digital 1 Block Heater 120V
1231H06	Digital 1 Block Heater 230V
1231H07	Digital 2 Block Heater 120V
1231H08	Digital 2 Block Heater 230V
1231H09	Digital 3 Block Heater 120V
1231H10	Digital 4 Block Heater 230V
1231H11	Digital 4 Block Heater 120V
1231H12	Digital 4 Block Heater 230V
1231H13	Digital 6 Block Heater 120V
1231H14	Digital 6 Block Heater 230V
1229E95	Temperature Probe Kit Heatblock Digitl



thermo scientific

## Check out these great offers from Thermo Scientific by June 30!

### Clicktainer Vials

Providing ultimate sample protection and user safety by ensuring correct cap application the first time

#### Thermo Scientific™ Samco™ Clicktainer™ Vials

Clicktainer vials have a wide opening and leak proof seal. The “click” seal system indicates when the cap is properly applied so the sample is secure. Sample collection and transport made easy!



Purchase 3 cases and get a case at no additional charge!

**SAVE NOW!**

### Transfer Pipettes

Conveniently transfer liquids with precision

#### Thermo Scientific™ Samco™ Transfer Pipettes are:

- Made of shatterproof, non-toxic polyethylene
- Can be frozen in liquid nitrogen, or heat sealed for storage
- Low-affinity surface reduces loss of cells and valuable proteins due to binding



Purchase 3 cases and get a case at no additional charge!

**SAVE NOW!**

### Loops and Needles

Precision molded to provide a smooth loop surface

#### Thermo Scientific™ Nunc™ Loops and Needles are:

- Precision molded from nontoxic (USP Class VI) polystyrene material to provide a smooth loop surface
- Made of high quality plastics for use in biotechnology, pharmaceutical and research laboratories
- Useful in the production of vaccines and diagnostic kits



Purchase 3 cases and get a case at no additional charge!

**SAVE NOW!**

Take advantage of these great product offers at:

[thomasci.com/deals](http://thomasci.com/deals)

**Thermo Fisher**  
SCIENTIFIC

For Research Use Only. Not for use in diagnostic procedures. © 2018 Thermo Fisher Scientific Inc. All rights reserved. All trademarks are the property of Thermo Fisher Scientific and its subsidiaries unless otherwise specified. TLBCONSAD 0218

# Dispensette S

Bottletop Dispenser **Buy 3, get 1 FREE!**

Setting the Standard for a Half Century!

#### BRAND Dispensette® S bottletop dispensers

- Reduced operating forces
- Easier maintenance
- Positive volume selection



Lab Rats Trust BrandTech®!

Details at [www.thomasci.com/deals](http://www.thomasci.com/deals)



**BRANDTECH**  
SCIENTIFIC, INC.

## Star™ T910 pH Titrators

Potentiometric titrator for accurate pH titrations with easily reportable results.

The **Thermo Scientific™ Orion™ T910 pH titrators** are designed to increase your laboratory productivity by automating titrations. Our core electrochemistry technology is integrated with a state-of-the-art reagent dispensing system to create modern, simplified automated titrators designed to make performing titrations easier, more reliable and more reproducible than manual titrations.

Use the **Orion Star T910 pH titrator** for dedicated acid-base titrations including:



- Titratable acidity of juices and wines
- Acidity of food products
- Alkalinity of waters
- Acidity and alkalinity of consumer products
- Total acid number (TAN)
- Total base number (TBN)

Titration techniques include equivalence point titrations and preset pH endpoint titrations for versatile sample analysis. The automated titrant delivery system with high-accuracy burette and dispenser provides consistent results. Automatic results calculations simplifies analysis and reduces computational errors.



Thomas No.	Description
1160V89	Orion Star T910 pH Titrator (without electrode), 100-240V, 50/60Hz
1160V90	Orion Star T910 pH Titrator Standard ROSS Kit, 100-240V, 50/60Hz
1160V91	Orion Star T910 pH Titrator ROSS Sure-Flow Kit, 100-240V, 50/60Hz

Visit [thomasci.com](http://thomasci.com) Search: 1160V89

thermo scientific



# Vials and Accessories

## Finneran R.A.M.™ Vials, 9mm

The Finneran R.A.M.™ Vials designed specifically to work in robotic arm autosamplers have a crimp style height with the convenience of a 9mm screw thread configuration. Choose from clear or amber Type I borosilicate glass. Vials are available with or without graduated marking spots and silanized.



Thomas No.	Description	Case
2695A01	2.0mL, Clear, R.A.M. Vial, 12x32mm, 9mm Screw Thread	1000
2695A07	2.0mL, Amber, R.A.M. Vial, 12x32mm, 9mm Screw Thread	1000
2695A25	2.0mL, Clear, R.A.M. Vial, 12x32mm, 9mm Screw Thread with White Graduated Marking Spot	1000
2695A55	2.0mL, Amber, R.A.M. Vial, 12x32mm, 9mm Screw Thread with White Graduated Marking Spot	1000

## Finneran Interlocked™ Vials

The Finneran Interlocked™ Vial is composed of a 12x32mm glass vial and a clear glass limited volume insert fused together. This design eliminates movement of the insert, allows more consistent sample recovery, eliminates needle damage and concerns about contaminants around the fused seam/space between the neck of the vial and the insert. Available with marking spots and silanized.



Thomas No.	Description	Case
1203J95	300uL Clear Interlocked™ Vial/Insert	100
1203M18	300uL Amber Interlocked™ Vial/Insert	100

## Finneran preassembled R.A.M.™ Smooth and Ribbed Screw Thread Closures with Septa, 9mm

Preassembled closures and septa come ready to use. Designed to work in robotic-arm autosamplers.



Smooth Closures			
Thomas No.	Description	Case	
1199N04	9mm R.A.M. Cap, Black, PTFE Lined	1000	
2695B60	9mm R.A.M. Cap, Black, PTFE/Butyl Rubber	1000	
1199N03	9mm R.A.M. Cap, Black, PTFE/Red Rubber	1000	
2695C01	9mm R.A.M. Cap, Black, PTFE/Silicone	1000	
2695C37	9mm R.A.M. Cap, Black, PTFE/Silicone/PTFE	1000	
1203J00	9mm R.A.M. Cap, Black, PTFE/Silicone w/Slit	1000	

Ribbed Closures			
Thomas No.	Description	Pack	Case
1199N02	9mm R.A.M. Cap, Black, PTFE Lined	100	1000
1203F50	9mm R.A.M. Cap, Black, PTFE/Butyl Rubber	100	1000
1203Y44	9mm R.A.M. Cap, Black, PTFE/Silicone	100	1000
1203Y49	9mm R.A.M. Cap, Black, PTFE/Silicone/PTFE	100	1000
1203Y55	9mm R.A.M. Cap, Black, PTFE/Silicone w/Slit	100	1000

## Finneran Glastic Vial Inserts

J.G. Finneran is the original designer and manufacturer of the Glass Insert/Plastic Outside Vial (Glastic). Glastic is a unique combination of Type I low extractable borosilicate glass insert and clear or amber thermoplastic polymer outer vial shell. The glass is the only contact between the sample and the seal.



Thomas No.	Description	Case
1203M09	100uL Glass Insert/Clear Plastic Vial (Glastic)	100
1203M10	100uL Glass Insert/Clear Plastic Vial (Glastic)	100

## Finneran polypropylene and TPX vials

Finneran polypropylene and TPX vials are an economical alternative to glass. Finneran polypropylene vials are manufactured from chemical resistant polypropylene and our TPX vials provide the clarity of glass and safety of polypropylene. Vials are also available in amber and black for light sensitive samples.

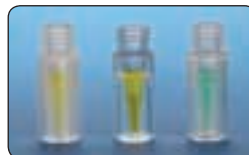

Thomas No.	Description	Case
2695A88	100uL Polypropylene R.A.M. Vial	1000
1203M11	100uL Clear Polypropylene R.A.M. Vial	1000
1203M12	100uL TPX R.A.M. Vial	1000
1203M43	500uL Polypropylene R.A.M. Vial	1000
1203M44	500uL Clear Polypropylene R.A.M. Vial	1000
1173F73	700uL Polypropylene R.A.M. Vial	1000
1171T69	1.7mL Polypropylene R.A.M. Vial	1000

## Finneran Inserts

Finneran inserts are available in glass and polypropylene and are available preassembled with a polymer bottom spring or patented Top Spring™. The polymer spring acts as a shock absorber that protects against breakage if the needle bottoms out. The conical design permits complete sample removal.



Conical Glass Inserts – Precision-Formed Mandrel Interior		
Thomas No.	Description	Case
2697J10	50uL Glass Big Mouth Insert with Bottom Spring	100
2697J34	100uL Glass Insert with Flange	100
2697J37	100uL Glass Insert with Patented Top Spring™	100
2697J58	250uL Glass Big Mouth Insert, No Spring	100
2697J61	250uL Glass Big Mouth Insert with Bottom Spring	100

Conical Glass Inserts – Pulled Point Interior		
Thomas No.	Description	Case
1190X63	250uL Glass Big Mouth Insert with Bottom Spring	1000
1190X62	250uL Glass Big Mouth Insert, No Spring	1000

Conical Polypropylene Inserts – Precision-Formed Mandrel Interior		
Thomas No.	Description	Case
2697J31	100uL Polypropylene Insert with Patented Top Spring	1000
1203M66	250uL Polypropylene Big Mouth Insert, No Spring	1000
1180X85	250uL Black Polypropylene Big Mouth Insert, No Spring	1000
2697J73	250uL Polypropylene Big Mouth Insert with Bottom Spring	1000
1181X56	250uL Black Polypropylene Big Mouth Insert w/Bottom Spring	1000

Visit [thomassci.com](http://thomassci.com) for full product information.

Keyword: Finneran



# CORNING

## Purchase Both: A Corning® CoolCell® Container and a Case of Corning Cryogenic Vials to Receive 1 Case of Cryogenic Vials Free

Go IPA-free and brighten up your lab.

Buy 1 Corning CoolCell Container (listed below), and...

Corning CoolCell Containers

Thomas Cat. No.	Corning Cat. No.	Description	Capacity (Vials)	Exposed Vial Tops	Qty/Cs	Compatible with 1.2 - 2 mL vials	Compatible with 4 - 5 mL vials
1167V72	432000	CoolCell, purple	12	No	1	■	
1167V21	432001	CoolCell LX, purple	12	Yes	1	■	
1167V22	432002	CoolCell LX, green	12	Yes	1	■	
1167V23	432003	CoolCell LX, orange	12	Yes	1	■	
1167V24	432004	CoolCell LX, pink	12	Yes	1	■	
1167V27	432005	CoolCell 5 mL LX, purple	12	Yes	1		■
1167V64	432006	CoolCell FTS30, purple	30	Yes	1	■	
1167V65	432007	CoolCell FTS30, orange	30	Yes	1	■	
1167V66	432008	CoolCell FTS30, green	30	Yes	1	■	
1167V67	432009	CoolCell FTS30, pink	30	Yes	1	■	

... 1 Case of Corning Cryogenic Vials (listed below), to receive 1 case of cryogenic vials free.\*

External Thread Cryogenic Vials

Thomas Cat. No.	Corning Cat. No.	Capacity (mL)	Style	Self-Standing	Qty/Pk	Qty/Cs
5151K46	430658	1.2	Conical bottom	Yes	50	500
5151K33	430659	2.0	Round bottom	Yes	50	500
5151K43	430661	2.0	Round bottom	No	50	500
5151K36	430662	4.0	Round bottom	Yes	50	500
5151K39	430663	5.0	Round bottom	Yes	50	500

Internal Thread Color Cap Cryogenic Vials

Thomas Cat. No.	Corning Cat. No.	Cap Color	Capacity (mL)	Style	Self-Standing	Type	Qty/Pk	Qty/Cs
1207P47	431416	Assorted	2.0	Round bottom	Yes	Washer	50	500
1207P48	431417	Yellow	2.0	Round bottom	Yes	Washer	50	500
1207P49	431418	Blue	2.0	Round bottom	Yes	Washer	50	500
1207P50	431419	Green	2.0	Round bottom	Yes	Washer	50	500
1207P51	431420	Red	2.0	Round bottom	Yes	Washer	50	500
1207P52	431421	White	2.0	Round bottom	Yes	Washer	50	500

Internal Thread Cryogenic Vials

Thomas Cat. No.	Corning Cat. No.	Capacity (mL)	Style	Self-Standing	Type	Qty/Pk	Qty/Cs
5151K13	430487	1.2	Conical bottom	Yes	Washer	50	500
5151K16	430488	2.0	Round bottom	Yes	Washer	50	500
5151K06	430489	2.0	Round bottom	No	Washer	50	500
5151K03	430490	4.0	Round bottom	No	Washer	50	500
5151K19	430491	4.0	Round bottom	Yes	Washer	50	500
5151K09	430492	5.0	Round bottom	No	Washer	50	500
5151K23	430656	5.0	Round bottom	Yes	Washer	50	500
1232E26	431386	2.0	Round bottom	Yes	Washer	50	250

\*Free item will be same as the cases purchased.

For purchases from January 2, 2018 to June 30, 2018 ■ Visit [www.thomassci.com/cls](http://www.thomassci.com/cls) for redemption info.



# Hamilton Microlab® 600 Diluters & Dispensers

## For Labs Processing Over 50 Samples Per Day

### Sample Prep Perfected

- ▶▶ Reduce sample preparation times
- ▶▶ Increase throughput and reduce errors
- ▶▶ Eliminate user-to-user variation
- ▶▶ Simplify compliance
- ▶▶ Free up valuable laboratory resources



**Lightweight hand probe**  
A lightweight, disposable tip hand probe is available



Thomas No.	Mfr. No.	Description
1220B14	ML610-DIS	Microlab® 600 Single Syringe Dispenser with Basic Controller
1221W13	ML620-DIS	Microlab® 600 Single Syringe Dispenser with Advanced Controller
1221W11	ML615-DIS	Microlab® 600 Dual Syringe Dispenser with Basic Controller
1221W15	ML625-DIS	Microlab® 600 Dual Syringe Dispenser with Advanced Controller
1221W12	ML615-CNT	Microlab® 600 Dual Syringe Continuous Dispenser with Basic Controller
1221W16	ML625-CNT	Microlab® 600 Dual Syringe Continuous Dispenser with Advanced Controller
1221W10	ML615-DIL	Microlab® 600 Dual Syringe Diluter with Basic Controller
1221W14	ML625-DIL	Microlab® 600 Dual Syringe Diluter with Advanced Controller
1221W18	61500-02	Microlab® 600 Basic to Advanced Controller Upgrade Kit Includes: Advanced Manual, 2 GB SD Card, SD to USB Converter, and the Programmer Software CD
1221W19	61500-03	Microlab® 600 Custom Programmer Kit (compatible with .Net 2.0) Includes: Programmer Software CD which contains the Programmer Manual, Application Programming Interface, and Example LabView, C#, and VB Programs
1216P36	61500-04	Microlab® 600 Printer Kit

For more information, visit [www.thomassci.com/Equipment/Dispensers/\\_/Microlab-600-Dispensers-and-Diluters](http://www.thomassci.com/Equipment/Dispensers/_/Microlab-600-Dispensers-and-Diluters)

1-800-345-2100

[www.thomassci.com](http://www.thomassci.com)

©2018 Hamilton Company. All rights reserved. All trademarks are owned and/or registered by Hamilton Company in the U.S. and/or other countries.



## YOUR CHOICE — Buy 2 GET 1 FREE!\*

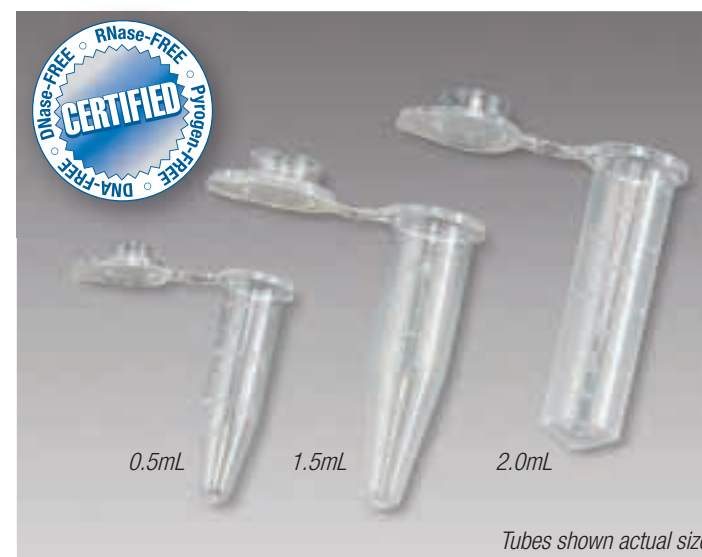

### 0.5mL, 1.5mL & 2.0mL Microcentrifuge Tubes In Self-Standing Bags

These premium quality microcentrifuge tubes are manufactured from FDA approved resins and are certified to be RNase free, DNase free, DNA free and Pyrogen free.

- Supplied in resealable, tamper-evident self-standing bags
- Large, clearly printed graduations
- Frosted writing area on each tube
- Smooth surfaces won't catch or tear gloves
- Thin cap membrane for trouble-free needle piercing
- Fit all standard and high capacity centrifuge rotors
- Can be centrifuged at up to 20,000 RCF
- Withstand temperatures from -80°C to +121°C
- Food grade
- Three volume and eight color options
- Polypropylene (PP)



\*Offers valid thru June 30, 2018. Mix & match. Item of equal or lesser value free.

Visit [thomassci.com/deals](http://thomassci.com/deals) for qualifying products and redemption forms.



### 5mL Macrocentrifuge Tubes Screw Cap & Snap Cap

Efficient, economical alternative to 15mL conical tubes when working with sample volumes between 2.0mL and 5.0mL.

#### 5mL Screw Cap Macrocentrifuge Tubes

- Single turn threaded caps seal easily and securely
- Graduated in 0.5mL increments
- Available non-sterile in bags and sterile in bags or foam racks
- Suitable for use from -86° to 80° C
- Polypropylene (PP) with polyethylene (PE) screw cap



#### 5mL Snap Cap Macrocentrifuge Tubes

- Convenience of 1.5mL microcentrifuge tube in a tube that holds larger volumes
- Attached snap cap facilitates one handed opening and closing
- Pierceable cap allows easy access by needle or syringe
- Dual graduation scales in increments of 0.5mL and 0.2mL
- Suitable for use from -86° to 80° C
- Seven color options
- Polypropylene (PP)





# The Original Lab Mill

Thomas Scientific  
Model 4  
Wiley® Mill



The Wiley Mill, by Thomas Scientific, sets the standard of quality, efficiency, and value within the sample preparation market. With over 75 years of proven technology, Wiley Mills are the **most robust, longest lasting mills on the market!**

The Wiley Mill is **built by hand** and consists of an **all steel construction**, with four rotating steel cutting knives, easy cleaning, **no service tech required for maintenance** and a one year manufacturer's warranty. The mills are suggested by the U.S. Bureau of Plant Industry for milling of samples.

**Whatever your application, Thomas has a Mill for you!**

- Bio-fuel
- Agriculture
- Tobacco
- Meat & Poultry
- Biology
- Life Science
- Pet Food

### Models for Bench Mounting

Provided with four mounting lugs for bolting to bench or for attachment of (3375E90)Runners (not supplied). Includes jar and beaker chutes, three sieves (1/2, 1 and 2 mm), one stainless steel beaker (1527C25), three 1 pint (0.47 L) glass jars (6176B12), set of wrenches, one grease gun and 1 lb. (0.45 kg) of grease.

- Overall dimensions: 15" W x 24" D x 28" H (381 x 610 x 711 mm)
- Shipping weight: 375 lbs. (170 kg)
- Net weight: 301 lbs. (136.5 kg)

Thomas No.	Description
3375E15	Wiley® Mill, Model 4 Bench, 1 Hp, 115V, 50/60 Hz
3375E25	Wiley® Mill, Model 4 Bench, 1 Hp, 230V, 50/60 Hz
3375E55	Wiley® Mill, Model 4 Floor, 1 Hp, 230V, 50/60 Hz

### Models with Floor Stand

- Heavy channel stock steel construction
- Smooth rolling casters
- Accessory shelf
- Overall dimensions: 20" W x 26" D x 49" H
- Shelf dimensions: 13.8" W x 15.9" D x 1.8" H
- Floor stand (3375E81) dimensions: 20" W x 25" D x 23" H

Floor stand models include jar and beaker chutes, three sieves (1/2, 1 and 2 mm) one stainless steel beaker (1527C25), three 1 pint (0.47 L) glass jars (6176B12), set of wrenches, one grease gun and 1 lb. (0.45 kg) of grease.

**For more information about Thomas Wiley Mills contact your Thomas Scientific Sales Representative today!**

Want a FREE Sample Grinding? Visit [www.thomassci.com/wileymill](http://www.thomassci.com/wileymill)

## Purchase 2 cases of KIMBLE® Disposable Culture Tubes Get a FREE universal tube rack

These premium quality tubes feature sturdy, uniform bottoms and consistent lengths. The 10x75mm and 12x75mm sizes are suitable for cell washing procedures.

- 51 expansion borosilicate glass offers excellent chemical resistance against sodium leaching, a factor common in soda lime glass products
- Tubes are packed in convenient trays for ease of use on bench tops and in drawers
- Trays are shrink-wrapped in plastic film, with tubes remaining in constant alignment for protection against in-transit breakage and contamination
- No marking spot
- Designed from ASTM Specification E890
- Manufactured from 51 expansion borosilicate glass conforming to USP Type I and ASTM E438, Type I, Class B requirements

Thomas Number	Overflow Capacity (mL)	OD x Length (mm)	Case Qty
1178Z90	4	10 x 75	1000
1178Z91	6	12 x 75	1000
1178Z92	10	13 x 100	1000
1178Z94	15	16 x 100	1000
1178Z95	19	16 x 125	1000
1178Z96	23	16 x 150	1000

Visit [www.thomassci.com/deals](http://www.thomassci.com/deals) for redemption info.



Part number 1185P30  
\*accommodates sizes 10-17mm

DWK Life Sciences

## qTOWER<sup>3</sup> Series Quantitative Real Time PCR Thermal Cyclers

**analytikjena**  
An Endress+Hauser Company

**Promo: Buy a qTOWER<sup>3</sup> - receive free equipment**

### qTOWER<sup>3</sup> Thermal Cyclers feature:

- Open platform for all common plasticware types (96 well plates, 8 or 12 well strips and individual tubes)
- Fast, efficient ramping rates: heating 8°C/sec; cooling 6°C/sec
- Optimized for volumes of 10 - 80 µl with detection of 96 samples in 6 sec, regardless of number of targets
- qTOWER<sup>3</sup> G includes gradient temperature range of up to 40°C across 12 columns/zones
- 10 year warranty on system optical components; 2 year warranty on remainder of system

**Free equipment valued at over \$3,000!**



**Free laptop** loaded with qPCRsoft software for control and analysis  
**Free color module 1** for SYBR Green/FAM/Alexa488 dyes  
**Free starter kit** with 96 well microplates and sealing films

Part #	Description	Price
1182K98	qTOWER <sup>3</sup> with free items	\$ 22,254.02
1182K99	qTOWER <sup>3</sup> G with free items	\$ 23,425.83

qTOWER 115V models listed. 10-year warranty provided on optical detection components. Additional color, FRET and protein modules available for loading up to 6 modules simultaneously. Go to [ThomasSci.com](http://ThomasSci.com) for additional specifications. Free items included with purchase. Offer valid in North America February 1, 2018 through March 31, 2019.



## WELCOME!

Thomas Scientific is a distributor of laboratory supplies, equipment and chemicals. The products in this catalog represent only a small offering from our extensive catalog and website. We're here to make your purchasing process as simple as possible. For additional models, sizes, packaging, and accessories not shown in our catalogs or if you just need help selecting a product, contact us at 800-345-2100 or visit us on the web at [www.thomassci.com](http://www.thomassci.com).



Thomas Scientific accepts VISA, Master Card, American Express and the IMPAC card for government buyers.

## OUR MISSION

To help science create a better world by providing quality products with personal, timely and efficient service  
*Delivering Quality Scientific Supplies Worldwide Since 1900*

Special offers and pricing are valid through June 30, 2018, unless otherwise noted.

**NOTE:** Offers in this catalog are void where prohibited by law or company policy. Shipping charges are not included. Prices and offers are subject to change without notice and are not to be combined with other offers/discounts or contract pricing. Valid in USA only. Dealer/reseller sales not applicable. For web orders, enter the promo code in the yellow box on the back of this catalog. For phone orders, please supply the promo code to the customer service representative when ordering. Discount pricing shown must be specified when placing order. Returned products will be subject to billing for Free Items at list price. Free items in 'Buy/Get 1 Free' offers will be the item of lowest value unless otherwise noted. Giveaways and free products may be shipped separately. Allow 4-6 weeks for delivery.

Suppliers featured in this issue are:



It's Just What Your Lab Needs

SUPPLIES • EQUIPMENT • INSTRUMENTS  
CHEMICALS • FURNITURE



Looking for additional offers?

Check out our

**Deal Central**

section on the web

[www.thomassci.com/deals](http://www.thomassci.com/deals)



**TS-B Series**  
Basic Portable Weighing  
Economical weighing  
Educational & general laboratory use

**TS-E Series**  
Economy Weighing  
Economy level balances / Basic weighing needs

**TS-L & TS-L.C Series**  
Standard Weighing  
Highly precise measurement

**TS-L.N Series**  
Standard Weighing  
with NTEP Certification

**TS-P Series**  
Portable Weighing  
Educational and light industrial use

**TS-T Series**  
Advanced Technology  
Advanced weighing performance  
Maximum ease-of-operation

**TS-U Series**  
Ultra-microbalances & microbalances  
Professional level of weighing  
Highest measurement accuracy

Please visit [thomassci.com](http://thomassci.com) Keywords: labForce Balances



Ansell

experience a  
**HIGHER LEVEL**  
of PROTECTION



Highest barrier  
quality & consistency\*  
(low 0.40 AQL)



**Microflex® 93-850 Nitrile Disposable Gloves with 2X more chemical splash protection†**

Introducing the innovative hand protection solution that stands up to tough jobs while significantly reducing workers' risk of exposure to hazardous materials and rips/tears. It's made using a breakthrough polymer bonding technique\* for 2X more chemical splash resistance.† And because these soft, durable gloves exceed the highest known standard for barrier quality and consistency,‡ they provide reliable protection in even the most challenging environments.

Request a sample at [ansell.com/microflex93850](http://ansell.com/microflex93850)

**MICROFLEX®**

\* Patent pending polymer bonding technique † Based on EN 374 and ASTM F739 chemical permeation test data, when compared to performance of disposable nitrile gloves of a similar weight. Visit [www.ansell.com/Microflex93-850chemtest](http://www.ansell.com/Microflex93-850chemtest) to view chemical permeation test data. ‡ Microflex 93-850 0.40 AQL is lower than the AQL of other known industrial and medical grade disposable gloves. Ansell, ® and ™ are trademarks owned by Ansell Limited or one of its affiliates. US Patented and US and non-US Patents Pending: [www.ansell.com/patentmarking](http://www.ansell.com/patentmarking) © 2018 Ansell Limited. All Rights Reserved.





## Are you taking advantage of all that Thomas Scientific has to offer?

Thomas Scientific offers our customers many ways to save. In addition to our competitive pricing, customers can take advantage of special offers through *LabBUYER*, *Lab BASICS*, *Safety Spotlight*, *Equipment and Instrumentation Source Guide*, and more.

The **Equipment and Instrumentation Source Guide** is full of deals and solutions for your laboratory needs. Get the latest information on new products as well as helpful tips to save you time and money.

The **LabBasics** winter publication is full of your everyday lab essentials at great prices.

The **Brewery and Wine Brochure** is focused around top quality products for this growing industry.

The **Safety Spotlight** is focused around our Safety partners and the many offerings of Safety products available to you. Here you will find new products, as well as some items that anyone who cares about Safety should have in their work environment. Discounts and great deals on Safety products await you.

The **Thomas Scientific Forensics Catalog**, along with the current Supplement, is packed with products focussed on the Forensics industry.

Ask your local Thomas Sales Representative for copies of these and other publications we have available. Many publications can also be downloaded on our website, in our Deal Central section. Visit the Promotions & Literature tab on ThomasSci.com today to see the latest publications and promotions.

Interested in seeing weekly specials and new product announcements? Check out our email blasts that feature unique product specials, many of which are exclusive to Thomas Scientific. To receive our email blasts on a regular basis, please register on our website!

**So ask yourself ... Am I taking advantage of all that Thomas Scientific has to offer?**

# lab BUYER

Spring Edition 2018

Supplies • Equipment • Instruments • Chemicals/Reagents



**Corning**  
Purchase a Corning® CoolCell™ Container and a Case of Corning Cryogenic Vials to Receive 1 Case of Cryogenic Vials Free.  
See Page 5



**labForce**  
Ultra-High Speed Centrifuge Tubes  
Buy 3, Get 1 FREE!  
See Page 11



**Thomas Wiley Mill**  
The Original Lab Mill  
See Page 18



**New!**  
**Stretchease**  
Powder-Free Nitrile Examination Gloves  
See Page 9



**Look inside for more great deals!**