

Microscope Slides & Accessories



Microscope Slides

Globe Scientific microscope slides are available through distributors worldwide and provide exceptional quality at considerable savings. Globe Scientific offers two lines of microscope slides to meet the demands of today's modern laboratory.

Our **Diamond White glass microscope slides** are produced from superior quality white glass and provide exceptional clarity, low self-fluorescence and uniform thickness. The glass is formulated for minimal oxidation, which ensures sample integrity during long-term storage. This top quality line is designed for the most demanding applications and provides considerable savings compared to other name brand white glass slides on the market.

Our **Classic microscope slides** are produced from the highest quality soda lime glass and are ideal for use in all routine applications. These slides provide excellent quality while offering substantial savings.

Globe Scientific microscope slides are offered in a large selection of colors, corner styles and edges. All slides are pre-cleaned and ready to use. Globe Scientific can also custom produce microscope slides for your particular needs. Please contact our sales department for more information.

Corner/Edge Types

Globe Scientific's microscope slides are available in 3 corner/edge styles. Choose the combination that best suits your application.

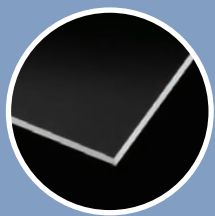

Traditional Style:
90° ground edge/90° corners.

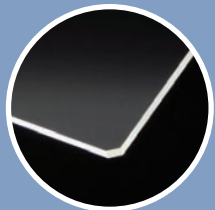

Safety Corners:
90° ground edge/slightly clipped corners.
Corners are slightly clipped for safety and comfort. (Available in Classic slides only.)

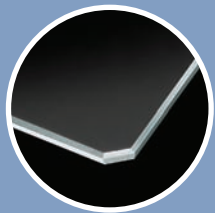

Clipped Corners:
45° beveled edge/clipped corners. No sharp edges. Perfect for blood smears.

Contents

Diamond White Glass Microscope Slides	3-6
Plain	3
Frosted	4
Color Coded	5
Charged	6
Instrument Specific	6
Classic Microscope Slides	7-9
Plain	7
Frosted	7
Color Coded	8
Cavity Well	9
Cover Glass	10
Slide Mailers	11
Slide Storage Boxes	12
Diamond PerfectSmear Blood Smear Device	13
Slide Staining	14
Slide Dispenser	14

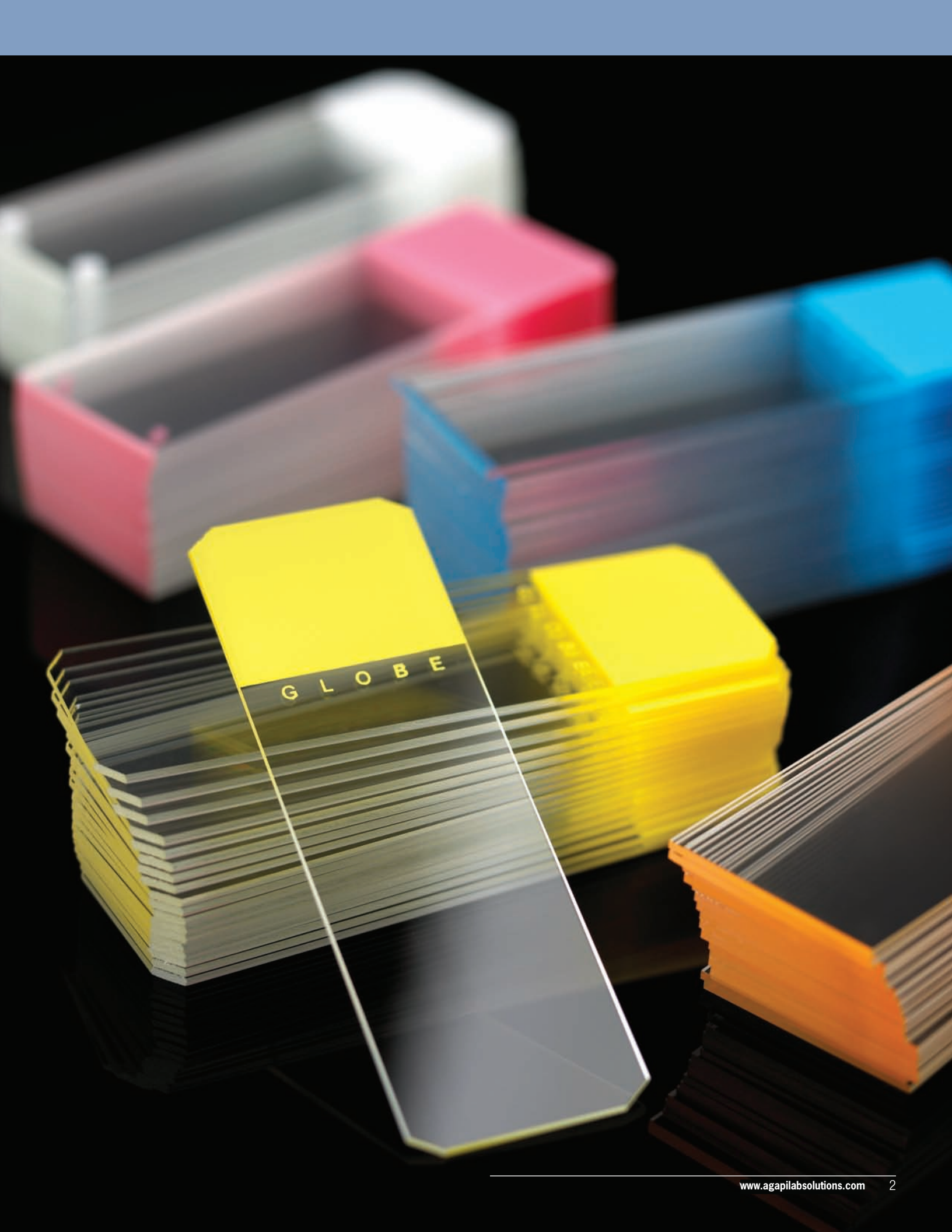

GLOBE

Why Diamond White Glass?

Globe Scientific's Diamond White Glass

microscope slides are made from chemically pure white glass sheets. The glass offers a low iron content which results in superior transparency, very low self-fluorescence and no color distortion. The special composition of the glass provides minimal oxidation, which ensures sample integrity during long-term storage. Increased hardness and molecular stability of the slide surface guarantees more accurate experimental results.

All Diamond White Glass microscope slides are packaged in high quality plastic boxes and double cellophane wrapped to protect against moisture and foreign particles. They are available in plain, frosted, color coded, charged and instrument specific versions.



All Diamond White Glass microscope slides are double cellophane packed in high quality plastic boxes to protect against moisture and foreign particles.

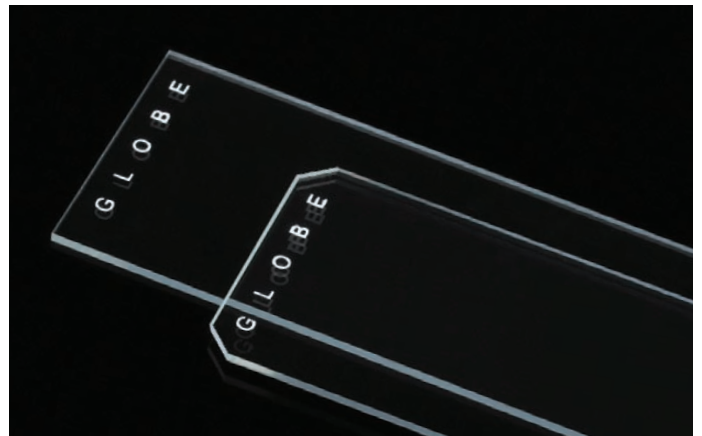

Plain Slides

Diamond White Glass plain microscope slides are available with 90° or clipped corners. Slides are pre-cleaned and ready to use.

- Produced from the finest quality optical white glass
- Packed in high-quality plastic boxes
- Dimensions: 25 x 75mm
- Thickness: 1mm
- Packaging: 72/plastic box, 20 boxes/case (10 gross)

Item #	Description	Unit
1380-10	Ground edges, 90° corners	1440
1384-10	Beveled edges, clipped corners	1440



Our Highest Quality

Diamond™ White Glass Microscope Slides

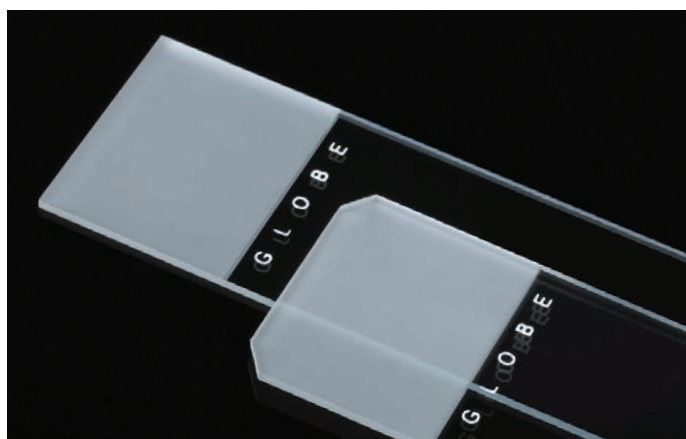

Frosted Slides

Diamond White Glass frosted microscope slides are produced using a unique chemical etching process. This provides our slides with a smooth frosted finish that won't wear out slide marking pens. Slides are pre-cleaned and ready to use. Available with 90° or clipped corners.

- Chemically etched on one end, one side
- Produced from the finest quality optical white glass
- Packed in high-quality plastic boxes
- Dimensions: 25 x 75mm
- Thickness: 1mm
- Packaging: 72/box, 20 boxes/case (10 gross)

Item #	Description	Unit
1380-20	Frosted 1 end, 1 side, ground edges, 90° corners	1440
1384-20	Frosted 1 end, 1 side, beveled edges, clipped corners	1440

Two-Sided Frosted Slides

These slides are chemically etched on both sides of one end. Smooth frosted finish won't wear out slide marking pens. Slides are pre-cleaned and ready to use. Available with 90° or clipped corners.

- Chemically etched on one end, two sides
- Produced from the finest quality optical white glass
- Packed in high-quality plastic boxes
- Dimensions: 25 x 75mm
- Thickness: 1mm
- Packaging: 72/box, 20 boxes/case (10 gross)

Item #	Description	Unit
1380-30	Frosted 1 end, 2 sides, ground edges, 90° corners	1440
1384-30	Frosted 1 end, 2 sides, beveled edges, clipped corners	1440

Color Coded Slides

Diamond White Glass color coded microscope slides are offered in bright, attractive colors. They are available with ground edges and 90° corners, or with beveled edges and clipped corners. All are printed with "Globe" under the color area for orientation purposes. They are pre-cleaned and ready to use.

- Color coded on one end, one side
- Produced from the finest quality optical white glass
- Packed in high-quality plastic boxes
- Dimensions: 25 x 75mm
- Thickness: 1mm
- Packaging: 72/plastic box, 20 boxes/case (10 gross)



Diamond White Glass

Microscope Slides



Ground Edge with 90° Corners

Item #	Description	Unit
1380-50A	Frosted, aqua	1440
1380-50B	Frosted, blue	1440
1380-50D	Frosted, gold	1440
1380-50G	Frosted, green	1440
1380-50L	Frosted, lilac	1440
1380-50N	Frosted, orange	1440
1380-50P	Frosted, pink	1440
1380-50T	Frosted, tan	1440
1380-50W	Frosted, white	1440
1380-50Y	Frosted, yellow	1440

Beveled Edge with Clipped Corners

Item #	Description	Unit
1384-50B	Frosted, blue	1440
1384-50G	Frosted, green	1440
1384-50N	Frosted, orange	1440
1384-50P	Frosted, pink	1440
1384-50W	Frosted, white	1440
1384-50Y	Frosted, yellow	1440

Additional colors available on special order.

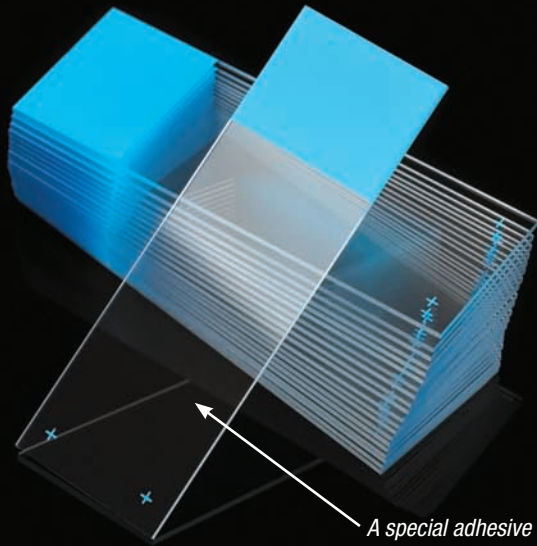

A special adhesive coating creates the ideal surface for cell and tissue adhesion.



Charged Slides

Produced using the finest quality white glass, Globe's charged microscope slides provide the ideal surface for cell and tissue adhesion. These popular slides are ideal for use in histology, cytology and pathology departments, where the convenience of an adhesive slide saves the user time and money. They are available in assorted colors and are pre-cleaned and ready to use.

- Adhesive surface
- Color coded on one end, one side
- Dimensions: 25 x 75mm
- Thickness: 1mm
- Packaging: 72/plastic box, 20 boxes/case (10 gross)

Ground Edge with 90° Corners

Item #	Color	Unit
1358A	Frosted, aqua	1440
1358B	Frosted, blue	1440
1358G	Frosted, green	1440
1358L	Frosted, lilac	1440
1358N	Frosted, orange	1440
1358P	Frosted, pink	1440
1358T	Frosted, tan	1440
1358W	Frosted, white	1440
1358Y	Frosted, yellow	1440

Beveled Edge with Clipped Corners

Item #	Color	Unit
1354P	Frosted, pink	1440
1354W	Frosted, white	1440
1354Y	Frosted, yellow	1440

Additional colors available on special order.

Instrument Specific White Glass Slides

This line of slides is designed specifically for use on popular automated instruments. The slides are specially cleaned for optimal performance in instruments.

- Produced from the finest quality optical white glass
- Packaged in high-quality plastic boxes
- Dimensions: 25 x 75mm
- Thickness: 1mm
- Packaging: 72/plastic box, 20 boxes/case (10 gross)

Ground Edge with Clipped Corners

Item #	Description	Unit
1365-10W	Frosted, white	1440



Classic Microscope Slides

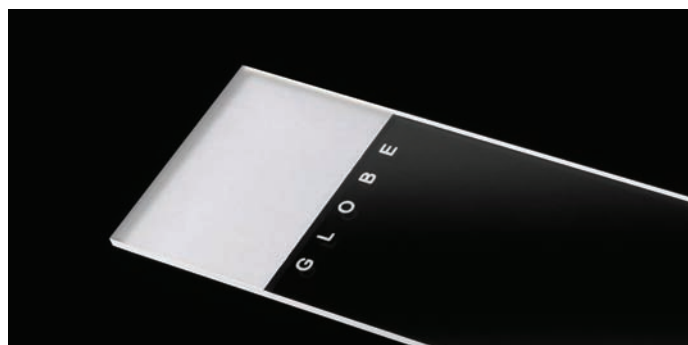
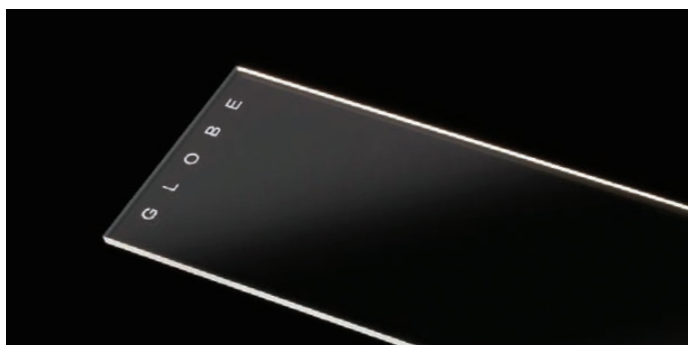

Plain Slides

Globe Scientific's plain microscope slides are available with your choice of corner styles: 90° corners, safety corners and clipped corners. Slides are pre-cleaned and ready to use.

- Dimensions: 25 x 75mm
- Thickness: 1.1mm
- Packaging: 72/box, 20 boxes/case (10 gross)

Item #	Description	Unit
1301	Ground edges, 90° corners	1440
1321	Ground edges, safety corners	1440
1331	Beveled edges, clipped corners	1440

Frosted Slides

Our frosted microscope slides are produced using a unique chemical etching process. This provides our slides with a smooth frosted finish that won't wear out slide marking pens. Slides are pre-cleaned and ready to use. Available with 90°, safety or clipped corners.

- Chemically etched on one end, one side
- Dimensions: 25 x 75mm
- Thickness: 1.1mm
- Packaging: 72/box, 20 boxes/case (10 gross)

Item #	Description	Unit
1304	Frosted 1 end, 1 side, ground edges, 90° corners	1440
1324	Frosted 1 end, 1 side, ground edges, safety corners	1440
1334	Frosted 1 end, 1 side, beveled edges, clipped corners	1440

Two-Sided Frosted Slides

These slides are chemically etched on both sides of one end. Smooth frosted finish won't wear out slide marking pens. Slides are pre-cleaned and ready to use. Available with 90°, safety or clipped corners.

- Chemically etched on one end, two sides
- Dimensions: 25 x 75mm
- Thickness: 1.1mm
- Packaging: 72/box, 20 boxes/case (10 gross)

Item #	Description	Unit
1308	Frosted 1 end, 2 sides, ground edges, 90° corners	1440
1328	Frosted 1 end, 2 sides, ground edges, safety corners	1440
1338	Frosted 1 end, 2 sides, beveled edges, clipped corners	1440



Our Classic Microscope Slides are available in 3 corner/edge styles. Choose the combination that best suits your application.

Color Coded Slides

Globe's color coded microscope slides are offered in bright, attractive colors. They are available in three corner/edge styles. The ground edge slide with 90° corners is perfect for use in automatic cover slip machines. The ground edge slide with safety corners provides slightly clipped corners for comfortable handling and to prevent the risk of finger and hand cuts. The beveled edge slide with clipped corners is ideal for performing blood smears. The highly polished edges are specially angled to 45° to provide a secure grasp during the smearing process. All slides are printed with "Globe" under the color area for orientation purposes. Slides are pre-cleaned and ready to use.

- Color coded on one end, one side
- Dimensions: 25 x 75mm
- Thickness: 1.1mm
- Packaging: 72/box, 20 boxes/case (10 gross)

Ground Edge with 90° Corners (1304 Series)

Item #	Color	Unit
1304B	Frosted, blue	1440
1304G	Frosted, green	1440
1304N	Frosted, orange	1440
1304P	Frosted, pink	1440
1304T	Frosted, tan	1440
1304W	Frosted, white	1440
1304Y	Frosted, yellow	1440

Ground Edge with Safety Corners (1324 Series)

Item #	Color	Unit
1324A	Frosted, aqua	1440
1324B	Frosted, blue	1440
1324D	Frosted, gold	1440
1324G	Frosted, green	1440
1324L	Frosted, lilac	1440
1324N	Frosted, orange	1440
1324P	Frosted, pink	1440
1324T	Frosted, tan	1440
1324W	Frosted, white	1440
1324Y	Frosted, yellow	1440

Beveled Edge with Clipped Corners (1334 Series)

Item #	Color	Unit
1334B	Frosted, blue	1440
1334G	Frosted, green	1440
1334P	Frosted, pink	1440
1334W	Frosted, white	1440
1334Y	Frosted, yellow	1440

Additional colors available on special order.

1304 Series

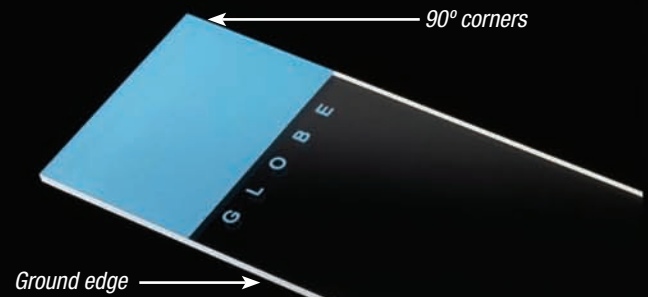

1324 Series



1334 Series

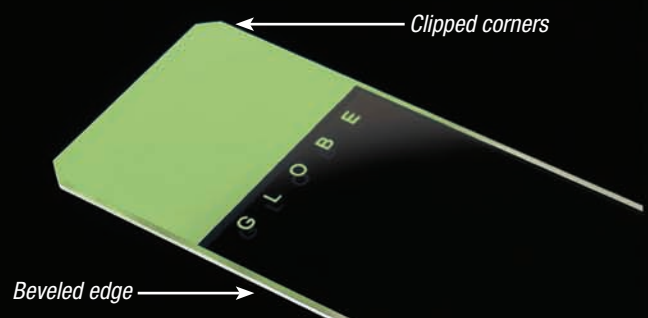

Classic Microscope Slides

Cavity Well Slides

Our cavity well microscope slides are ideal for holding liquids and cultures for microscopic examination. They are offered with 90° ground edges and feature our popular safety corners. Two styles are available: single or double cavity.

- Pre-cleaned and ready to use
- Spherically polished cavities are 13mm diameter with 0.2-0.4mm depth
- Dimensions: 25 x 75 x 1mm
- Packaging: 72/box, 20 boxes/case (10 gross)

Item #	Description	Packaging Options
1341	Single cavity, ground edges, safety corners 72/box, 20 boxes/case	72 & 1440
1344	Double cavity, ground edges, safety corners 72/box, 20 boxes/case	72 & 1440

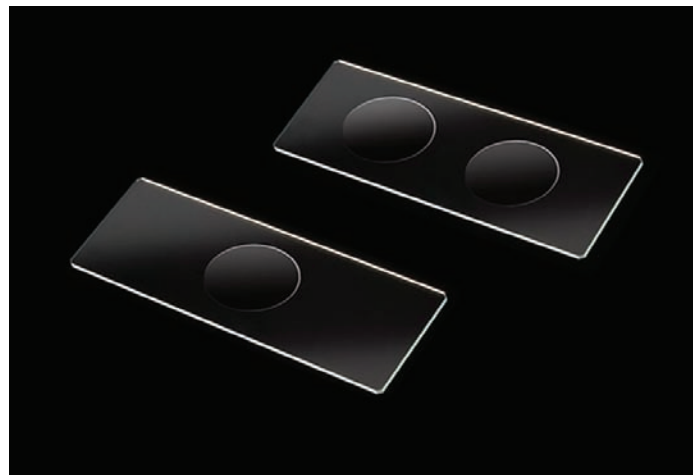

Single Cavity

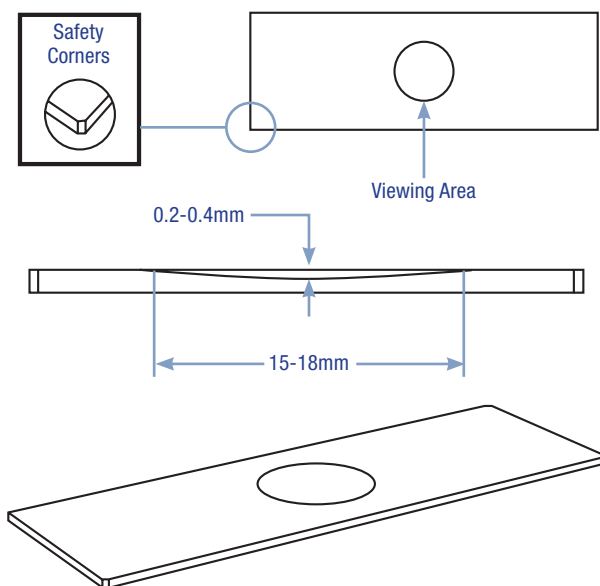

Double Cavity

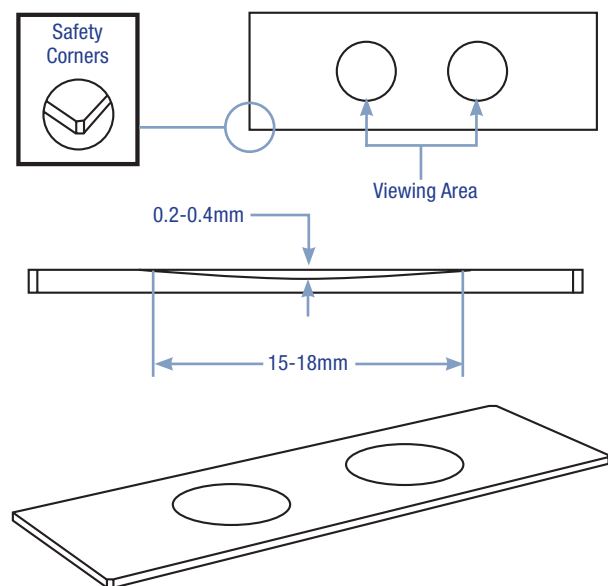

Microscope Slide Cover Glass



White Glass Cover Glass

Globe Scientific cover glass is packaged: 1 oz per box, 10 boxes per carton (10 oz). Each flip top box contains a desiccant and is vacuum sealed in aluminum to prevent sticking.

Available in three thicknesses:

- No. 1: 0.14mm
- No. 1.5: 0.175mm
- No. 2: 0.21mm

Item #	Description	Unit	Approximate Pcs per 1 oz Box
1401-10	18 x 18mm, No. 1	10 oz	248
1401-20	18 x 18mm, No. 2	10 oz	168
1402-10	20 x 20mm, No. 1	10 oz	192
1402-20	20 x 20mm, No. 2	10 oz	154
1404-10	22 x 22mm, No. 1	10 oz	168
1404-15	22 x 22mm, No. 1.5	10 oz	148
1404-20	22 x 22mm, No. 2	10 oz	136
1407-10	22 x 32mm, No. 1	10 oz	114
1407-20	22 x 32mm, No. 2	10 oz	84
1411-10	22 x 40mm, No. 1	10 oz	86
1411-20	22 x 40mm, No. 2	10 oz	75
1414-10	22 x 50mm, No. 1	10 oz	70
1414-20	22 x 50mm, No. 2	10 oz	63
1418-10	22 x 60mm, No. 1	10 oz	60
1418-20	22 x 60mm, No. 2	10 oz	50
1405-10	24 x 24mm, No. 1	10 oz	141
1405-20	24 x 24mm, No. 2	10 oz	102
1408-10	24 x 32mm, No. 1	10 oz	104
1408-20	24 x 32mm, No. 2	10 oz	78
1412-10	24 x 40mm, No. 1	10 oz	82
1412-20	24 x 40mm, No. 2	10 oz	71
1415-10	24 x 50mm, No. 1	10 oz	65
1415-15	24 x 50mm, No. 1.5	10 oz	56
1415-20	24 x 50mm, No. 2	10 oz	56
1419-10	24 x 60mm, No. 1	10 oz	55
1419-20	24 x 60mm, No. 2	10 oz	46



Slide Mailers

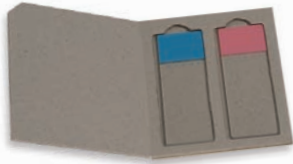
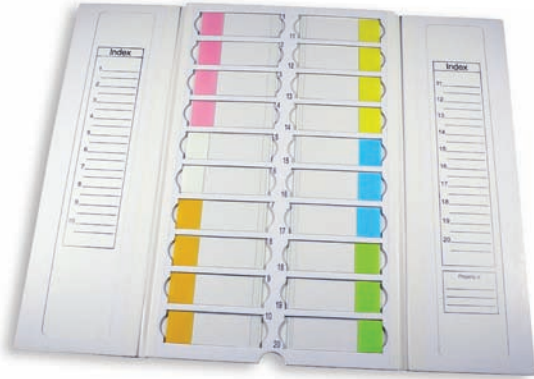

Extra Sturdy Plastic Slide Mailers

Our plastic slide mailers are produced from polypropylene (PP) and feature a snap-close lid to keep slides secure during transport.

Item #	Description	Packaging Options
513031	Holds 1 slide, 100/box, 1000/case	100 & 1000
513041	Holds 2 slides, 100/box, 1000/case	100 & 1000
513041B	Holds 2 slides, blue, 100/box, 1000/case	100 & 1000
513045	Holds 3 slides, 100/box, 1000/case	100 & 1000

Cardboard Slide Mailers

Globe Scientific's cardboard slide mailers securely hold slides with or without a cover-glass. They feature an inner finger groove for effortless slide removal along with a cover that opens for viewing. The flat surface area is ideal for labeling or writing any necessary information. They are light-weight and reusable to minimize cost. The 20-place cardboard slide holder contains a numerical index that corresponds to the inner slide compartments. The inside flaps are recessed so that there is no contact or contamination between the slides and the cover when closed. With a 360° hinge, the cover folds flat underneath to save space when the holder is in use.

Item #	Description	Packaging Options
513001	Holds 1 slide, 100/box, 1000/case	100 & 1000
513002	Holds 2 slides, 50/box, 1000/case	100 & 1000
513003	Holds 3 slides, 50/box, 500/case	50 & 500
513004	Holds 4 slides, 50/box, 200/case	50 & 200
513025	Holds 20 slides, 10/case	1 & 10



Plastic Slide Mailers with Flip Top Lids

These compact plastic slide mailers are produced from polypropylene (PP) and feature a flip-top lid to keep slides secure during transport. The slim design saves valuable space and features inner slots which keep slides separated.

Item #	Description	Packaging Options
513052	Holds 2 slides, natural, 100/box, 1000/case	100 & 1000
513052B	Holds 2 slides, blue, 100/box, 1000/case	100 & 1000
513062	Holds 5 slides, natural, 100/box, 1000/case	100 & 1000
513062B	Holds 5 slides, blue, 100/box, 1000/case	100 & 1000
513062LB	Holds 5 slides, light blue, 100/box, 1000/case	1000

Slide Storage Boxes

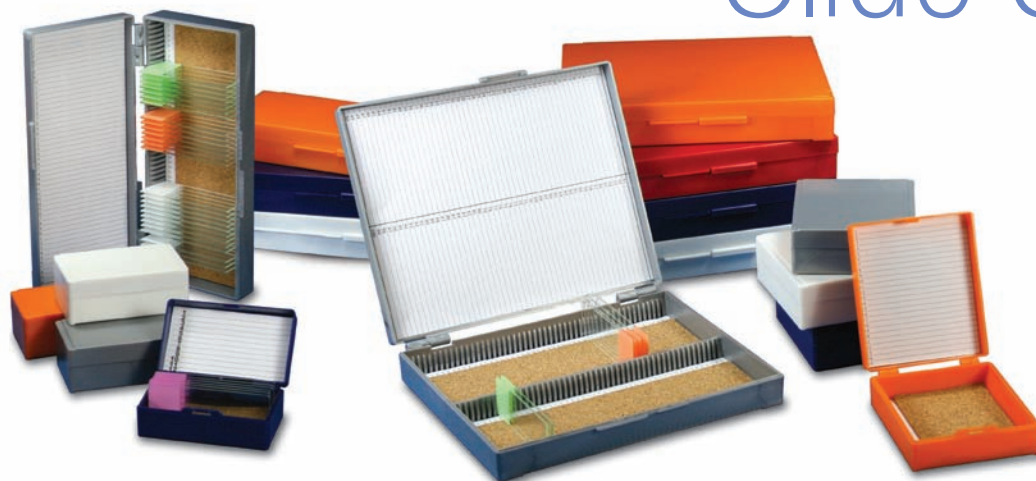

NEW!

Slide Storage Boxes

Globe Scientific's microscope slide storage boxes are produced from durable ABS plastic and offer a hinged lid for easy opening and closing. An inventory sheet is affixed to the inside cover for convenient slide identification and organization. The base of the box is cork lined for added protection. Available in four sizes and various colors, these storage boxes accommodate 25 x 75mm and 1" x 3" microscope slides.

For 12 Slides

Item #	Color	Unit	Item #	Color	Unit
513072A	Gray	1	513072N	Orange	1
513072B	Blue	1	513072W	White	1
513072G	Dark gray	1	513072AST	(1 ea. A, B, G, N, W)	5

For 25 Slides

Item #	Color	Unit	Item #	Color	Unit
513075A	Gray	1	513072N	Orange	1
513075B	Blue	1	513075W	White	1
513075G	Dark gray	1	513075AST	(1 ea. A, B, G, N, W)	5

For 50 Slides

Item #	Color	Unit	Item #	Color	Unit
513077A	Gray	1	513077N	Orange	1
513077B	Blue	1	513077W	White	1
513077G	Dark gray	1	513077AST	(1 ea. A, B, G, N, W)	5

For 100 Slides

Item #	Color	Unit	Item #	Color	Unit
513079A	Gray	1	513079R	Red	1
513079B	Blue	1	513079W	White	1
513079G	Dark gray	1	513079AST	(1 ea. A, B, G, N, W)	5
513079N	Orange	1			

Heavy-Duty Slide Storage Boxes with Stainless Steel Clasp

These stackable boxes are produced from durable ABS plastic and feature heavy-duty stainless steel clasps and hinged lids for easy opening and closing. An inventory sheet is affixed to the inside cover for convenient slide identification and organization. The base of the box is cork lined for added protection. Available in 6 colors, these storage boxes accommodate 25 x 75mm and 1" x 3" microscope slides.

For 100 Slides

Item #	Color	Unit
513080A	Gray	1
513080B	Blue	1
513080G	Dark gray	1
513080N	Orange	1
513080R	Red	1
513080W	White	1
513080AST	(1 each: A, B, G, N, W)	5



Diamond PerfectSmear™

For a perfect smear every time . . .



NEW!

Diamond PerfectSmear™ Blood Smear Device

The perfect solution for safe, error-free blood smears every time. The tool features tapered ends for uniform smearing. Lightweight flexible design protects blood cells from destruction that occurs when using glass slides.

- Easier to achieve consistent, accurate smears
- More cost efficient than glass microscope slides
- Safe polystyrene construction eliminates cuts to hands and fingers

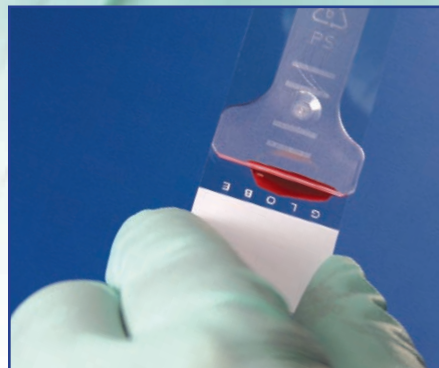

Item #	Description	Packaging
1300	Diamond PerfectSmear™	72/bag

To use the Diamond PerfectSmear™:
Orient the PerfectSmear™ spatula so that the beveled edge is facing down (the raised lines will be facing up). Applying light pressure, simply create smear using your preferred technique.

Slide Accessories

Slide Staining Products

Globe Scientific offers three great products to simplify the staining process. The staining rack is produced from polyoxymethylene (POM) and is designed for the simultaneous staining of up to 25 microscope slides. The staining dish is designed for use with our staining rack and features a lid that holds up to 25 slides for upright drying. The storage box is produced from polystyrene (PS) and holds up to 4 staining racks (100 slides). The inside lid of the box contains a detailed slide index sheet to keep slides organized.

Item #	Description	Unit
513220	Staining rack, for 25 slides	1
513222	Staining dish, for 25 slides	1
513224	Storage box (holds 4 staining racks)	1



Slide Dispenser

The Globe slide dispenser is designed for use with 25 x 75mm and 1" x 3" microscope slides. The dispenser prevents slides from getting dirty, dusty and scratched. To use, simply insert the contents of one full box of 72 slides into the holder. Turn the dial to dispense one slide at a time.

Item #	Description	Unit
513000	Dispenser for 72 slides	1

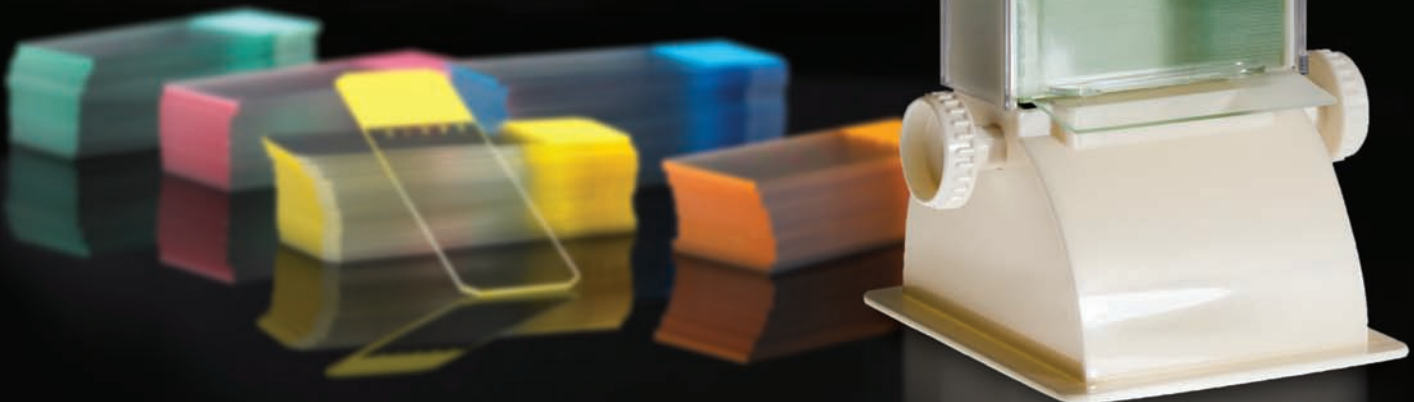

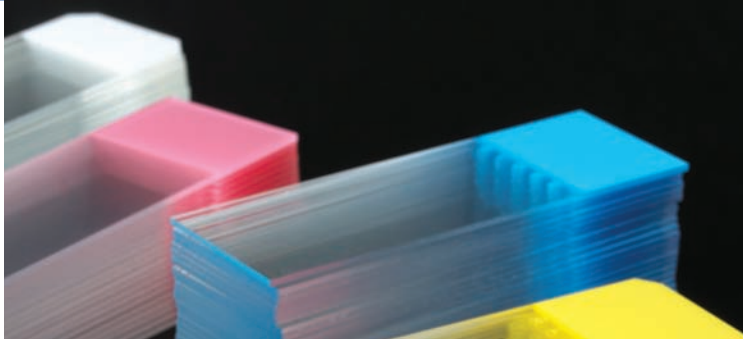

EXCEPTIONAL QUALITY LAB SUPPLIES

Globe Scientific is a leading producer of high-quality laboratory plasticware, glassware and equipment. Our products are sold worldwide and are used in many industries including Clinical, Research, Hospital, Veterinary and Specialty markets.

- Analyzer consumables
- Bags
- Beakers
- Bench-top equipment
- Biohazard specimen bags
- Blood collection products
- Bottles
- Capillary tubes
- Centrifuge tubes
- Containers
- Cryogenic tubes
- Cylinders
- Cytology products
- Drug test containers
- Drying rack
- ESR systems
- Formalin filled containers
- Formalin neutralization
- Funnels
- Histology cassettes
- Inoculation loops
- Microhematocrit tubes
- Microscope slides
- Micro test plates
- Pathology containers
- Pipettors
- Pipette tips
- Racks
- Serological pipettes
- Slide mailers
- Test tubes
- Transfer pipets
- Urinalysis
- Weighing dishes



www.agapilabsolutions.com

Contact Us:

Phone 1 (267) 397-3345

E-mail customerservice@agapilabsolutions.com

Distributed by:

© 2013 Globe Scientific Inc. All rights reserved.
The Globe Scientific logo is a registered trademark of Globe Scientific Inc.
The Diamond logo is a trademark of Globe Scientific Inc.